

# Changing our landscape

Landscaping Solutions Collection 2018



TALASEY

GROUP





# Welcome to Talasey

The UK's leading independent supplier of landscaping solutions

**The Talasey Group brings together a diverse and high quality range of landscaping products, providing designers, landscape architects, installers and home owners with a one stop shop from which to create inspired outdoor living spaces.**

Our collection is one of the UK's largest ranges of landscaping materials, with options to suit all tastes, projects and budgets as we provide:

- **Natural Paving;** The very best natural stone landscaping materials from across the world. The majority of our stone is Indian sandstone, which follows a careful journey that we oversee from quarry to your garden. In addition, the range also offers Chinese quartz and Portuguese granite.
- **Vitripiazza;** Vitrified porcelain paving is carefully sourced from Italy which is renowned for its superior quality vitrified porcelain.
- **Baksteen;** A Dutch range of cosmopolitan handmade clay pavers and bricks.
- **Luxigraze;** High quality artificial grass and extensive range of installation and cleaning accessories.
- **Pavetuf;** Landscaping installation, maintenance and cleaning products.
- **Resiscape;** A resin bound aggregate system with a complementary range of installation accessories.

We hope you enjoy our collection.





**8 Vitripiazza**  
Italian vitrified porcelain paving

- |                     |                       |
|---------------------|-----------------------|
| <b>12</b> Di Pietra | <b>22</b> Albero      |
| <b>14</b> Oceano    | <b>24</b> Anno        |
| <b>16</b> Sabbia    | <b>26</b> Stile       |
| <b>18</b> Granito   | <b>28</b> Accessories |
| <b>20</b> Moderno   |                       |



**30 Natural Paving**  
Natural stone landscaping materials

- |   |   |
|---|---|
| <b>34 Premiastone</b><br><i>Sawn, honed &amp; textured flagstones</i> | <b>122 Cobblestone</b><br><i>Weathered, split and honed cobbles and setts</i> |
| <b>64 Cragstone</b><br><i>Weathered flagstones</i>                    | <b>130 Walling</b>  |
| <b>76 Classicstone</b><br><i>Riven standard flagstones</i>            | <b>132 Stone Accessories</b><br><i>Finishing touches</i>                      |
| <b>102 Fossestone</b><br><i>Weathered natural stone block paving</i>  |   |



**140 Baksteen**  
Dutch clay pavers

- 142** Continental
- 144** Dutch Square



**146 Luxigraze**  
Artificial grass & accessories

- 148** Luxigraze Grass
- 150** Luxigraze Accessories



**152 Pavetuf**  
Installation & maintenance products

- 154** Installation
- 156** Sealants
- 158** Specialist Cleaners

**160 Resiscape**  
Resin bound aggregate system & accessories

- 162** Resin Bound Aggregate System
- 164** Accessories



# Why The Talasey Group



**The Talasey Group works tirelessly to offer the very best product range and deliver consistently high levels of customer service. As a leading provider of landscaping solutions:**

- We offer a one stop shop for all landscaping needs. Our founding brand Natural Paving, ensures a full end to end solution as we quarry, manufacture, import and distribute our own natural stone products, caring for them at each step of their journey.
- We ensure our products are of the highest quality and comply with the latest industry regulations. Where required, products are CE marked and have full test data available. (See the respective brand website for details.)
- Our products are imported from a number of countries across Europe and Asia to offer the best in choice and care is taken to ensure that they are ethically sourced. We are members of the Ethical Trading Initiative (ETI) and invest whole heartedly in our supply chain and the people that work in it, going above and beyond the requirements of the ETI.
- We offer a range of commercial products and a bespoke supply service. For more details please refer to page 136.



## Purchasing our products

**We have an extensive network of reputable stockists across the UK including builders merchants, landscape centres and garden centres, from which to purchase our products. Simply contact the Internal Sales Team for details of your nearest stockist or visit our website:**

**[www.talasey.co.uk/buying-from-talasey](http://www.talasey.co.uk/buying-from-talasey)**

If you have any questions please contact our Internal Sales Team on:

**Tel: 0330 333 8030 Fax: 0330 333 8040**

**Email: [info@talasey.co.uk](mailto:info@talasey.co.uk)**

**Talasey House, Belton Road, Sandtoft, Doncaster, DN8 5SX**

## Exceptional customer service

As a wholesaler, we work hard to ensure that our retailers, trade customers and consumers are looked after.

The success of the Talasey Group has been underpinned by providing the highest standards in product quality and excellent customer care. Our reliability is recognised by the industry and has been rewarded by The British Association of Landscape Industries (BALI) for a number of years, with an award for delivering 'Exceptional Customer Service'.

Constantly developing our professional operations, we hold the following certifications and are active members of the UK's key trade associations.



**Please note:** If there is any issue with the product once it has been received we request that you do not use/install it and notify your stockist as soon as possible. Once installed, the product is deemed to have been accepted. See our terms and conditions for further details.

## Installation and design – Landscaping Professionals

If you, like many others, need a hand to design your dream garden or install your new landscaping products, we can suggest local and independent designers, contractors and installers, through our landscaping professionals membership scheme.

Find a list of your local designers and installers on our website:

**[www.naturalpaving.co.uk/landscaping-professionals](http://www.naturalpaving.co.uk/landscaping-professionals)**

Each member is listed because they use and are familiar with our products.



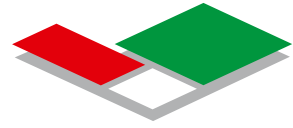

# VITRIPIAZZA®

Vitrified Porcelain Paving



# The Vitripiazza Collection

Vitripiazza is a high quality, vitrified, Italian porcelain paving. Vitripiazza offers 26 different colours across 8 beautiful ranges, with a wide selection of accessories to create the perfect finishing touches.

## Benefits of Vitripiazza flagstones

Vitripiazza flagstones are a full bodied porcelain, meaning that the entirety of each flagstone is made from high quality porcelain, as opposed to cheaper vitrified ceramic tiles or alternatives that may just have a porcelain layer on the surface. Also, all of the edges are rectified, as they are machine milled to produce crisp, smooth edges, for ease of installation and to enable very neat joints / lines to be achieved. Not only do the Vitripiazza flagstones offer a varied colour blend that reflects natural products, they also provide home owners with the ultimate choice in durability, longevity and style as they are:

- ✓ Highly durable
- ✓ Resistant to attack from moss, mould and pesticides
- ✓ Resistant to salt
- ✓ Non absorbent (<0.1%)
- ✓ Frost proof
- ✓ Easy to clean

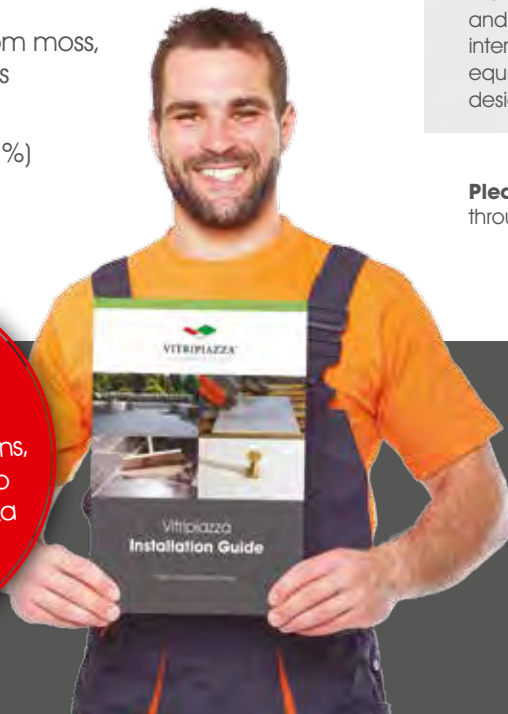

Please visit [www.vitripiazza.co.uk](http://www.vitripiazza.co.uk) for further product information, laying patterns, product images and to download the Vitripiazza installation guide.

## Bringing the outside in

The Vitripiazza range is available in 20mm thick flagstones, designed for external use. To enable you to bring the outdoors in and create a flush finish from your garden into your home, we offer most of the Vitripiazza products in 10mm thick single size floor tiles for internal use. The Anno and Moderno ranges are not available in a 10mm internal tile.

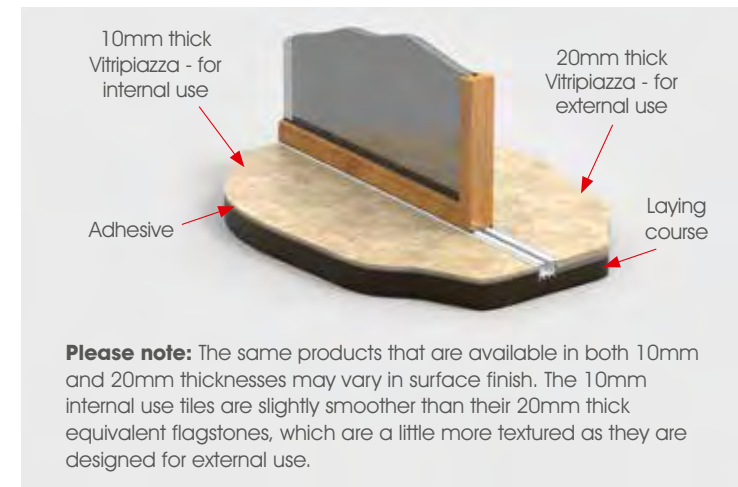

**Please note:** All product sizes, weights and coverages stated throughout this brochure are nominal.

Please note: We recommend that Vitripiazza is only installed using Pavetuf Priming Slurry and jointed with either our Jointing Mortar or Jointing Compound. If these products are not used for Vitripiazza installation purposes, the integrity of the paved system is outside our recommend guide and will forfeit any technical support.

Vitripiazza is available in a range of product options including project packs, single sizes and circle kits.

**Please note:** As Vitripiazza products are produced in batches, we advise that sufficient product for each project is purchased together and from the same batch, as there may be slight colour variations between different batches. Also mixing different size formats and different pack sizes may result in colour variations, so care needs to be taken when designing and ordering these products.



## Di Pietra

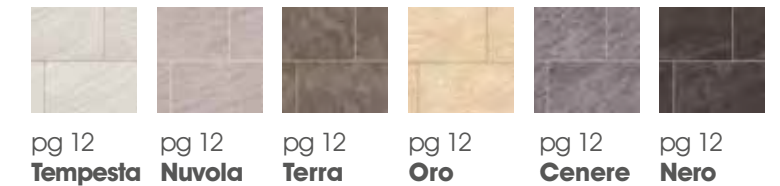

## Oceano

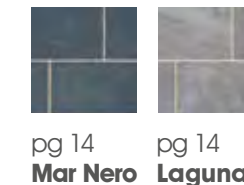

## Sabbia



## Granito

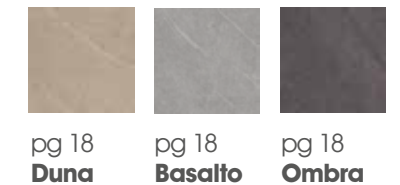

## Moderno

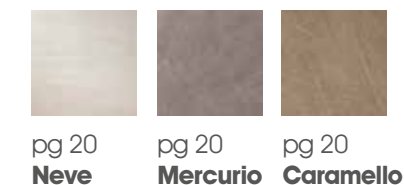

## Albero

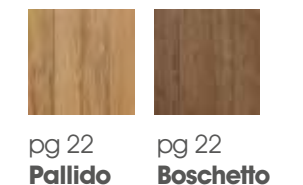

## Anno

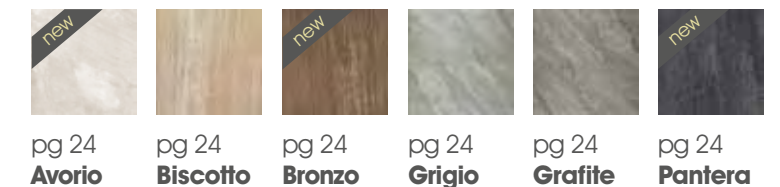

## Stile



## Accessories

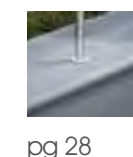



Nuvola with Tempesta on the raised paved area

# Di Pietra



MADE IN ITALY

With 6 colours to choose from, Di Pietra presents a contemporary range inspired by nature to give a slightly textured, random, natural stone finish. In addition to project packs and single sizes, Di Pietra is also available in circle kits, see page 29 for details.



Tempesta

Nuvola

Terra

Oro

Cenere

Nero

Product - External Use	Nominal Thickness (mm)	Nominal weight per pack (kg)	Nominal coverage per pack (m <sup>2</sup> )	Number of pieces per pack					
				Please note that sizes are nominal					
				1200mm x 600mm	1200mm x 400mm	900mm x 450mm	600mm x 600mm	600mm x 300mm	300mm x 300mm
Project Pack	20	720	15.3	-	-	-	22	27	28
1200 x 600mm Single Size	20	501	10.80	15	-	-	-	-	-
1200 x 400mm Single Size*	20	1100	23.00	-	48	-	-	-	-
900 x 450mm Single Size	20	1020	21.87	-	-	54	-	-	-
600 x 600mm Single Size	20	1010	21.60	-	-	-	60	-	-
600 x 300mm Single Size	20	990	21.60	-	-	-	-	120	-
<b>Product - Internal Use**</b>									
900 x 450mm Single Size	10	1215	43.74	-	-	108	-	-	-
600 x 600mm Single Size	10	1080	43.20	-	-	-	120	-	-

\*Not available in Oro. \*\*All internal use, 10mm thick tiles and 1200 x 400mm external tiles can be ordered in bespoke pack sizes to suit any size project. Please allow a minimum of 2 - 3 weeks for these to be delivered into your stockist.

Please note that the external use 1200 x 400mm single sizes are available to order as single pieces with 1 per pack. The 1200 x 400mm, 900 x 450mm and 600 x 600mm single sizes are also available to order in packs of 2.



# Oceano



MADE IN ITALY

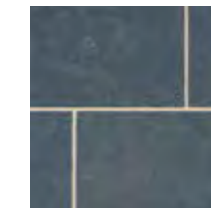

Mar Nero

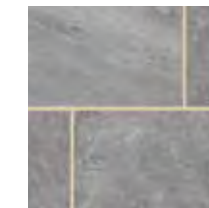

Laguna

Oceano provides a smooth flagstone, characterised with a random shale and fossil trace pattern. Oceano is available in a choice of 2 nautical colours, Mar Nero and Laguna.

Product - External Use	Thickness (mm)	Nominal weight per pack (kg)	Nominal coverage per pack (m <sup>2</sup> )	Number of pieces per pack
600 x 600mm Single Size	20	1010	21.6	60
Product - Internal Use*				
600 x 600mm Single Size	10	1080	43.2	120



We recommend the black Pavetuf Jointing Compound to joint this product



See page 155 **Pavetuf**

Mar Nero

\*All internal use, 10mm thick tiles can be ordered in bespoke pack sizes to suit any size project. Please allow a minimum of 2 - 3 weeks for these to be delivered into your stockist.

Please note that the external use 600 x 600mm single sizes are also available to order in packs of 2.





Sole

Porcelain paving has been bonded to the sub base using the Pavetuf Priming Slurry



See page 154 **Pavetuf**

# Sabbia

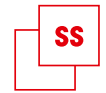

MADE IN ITALY

Sole

Sole has a sunkissed glow and random, natural stone travertine finish.

Product - External Use	Thickness (mm)	Nominal weight per pack (kg)	Nominal coverage per pack (m <sup>2</sup> )	Number of pieces per pack
600 x 600mm Single Size	20	1010	21.6	60
Product - Internal Use*				
600 x 600mm Single Size	10	1080	43.2	120



\*All internal use, 10mm thick tiles can be ordered in bespoke pack sizes to suit any size project. Please allow a minimum of 2 - 3 weeks for these to be delivered into your stockist.

Please note that the external use 600 x 600mm single sizes are also available to order in packs of 2.



# Granito

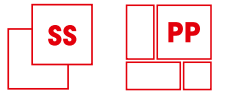

MADE IN ITALY

A stunning granite effect range, in a choice of 3 colours Granito offers a natural riven effect and delicate sparkle.

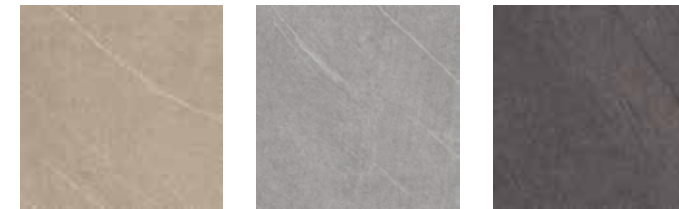

Duna

Basalto

Ombra

Product - External Use	Thickness (mm)	Nominal weight per pack (kg)	Nominal coverage per pack (m <sup>2</sup> )	Number of pieces per pack			
				Please note that sizes are nominal			
				1200mm x 600mm	600mm x 600mm	600mm x 300mm	300mm x 300mm
Project Pack	20	720	15.3	-	22	27	28
1200 x 600mm Single Size	20	501	10.80	15	-	-	-
600 x 600mm Single Size	20	1010	21.60	-	60	-	-
600 x 300mm Single Size	20	990	21.60	-	-	120	-
Product - Internal Use*							
600 x 600mm Single Size	10	1080	43.2	-	120	-	-
600 x 300mm Single Size	10	960	43.2	-	-	240	-

\*All internal use, 10mm thick tiles can be ordered in bespoke pack sizes to suit any size project. Please allow a minimum of 2 - 3 weeks for these to be delivered into your stockist.

Please note that the external use 1200 x 600mm single size pieces are available to order as individual pieces, the 600 x 600mm in packs of 2 and 600 x 300mm in packs of 3.

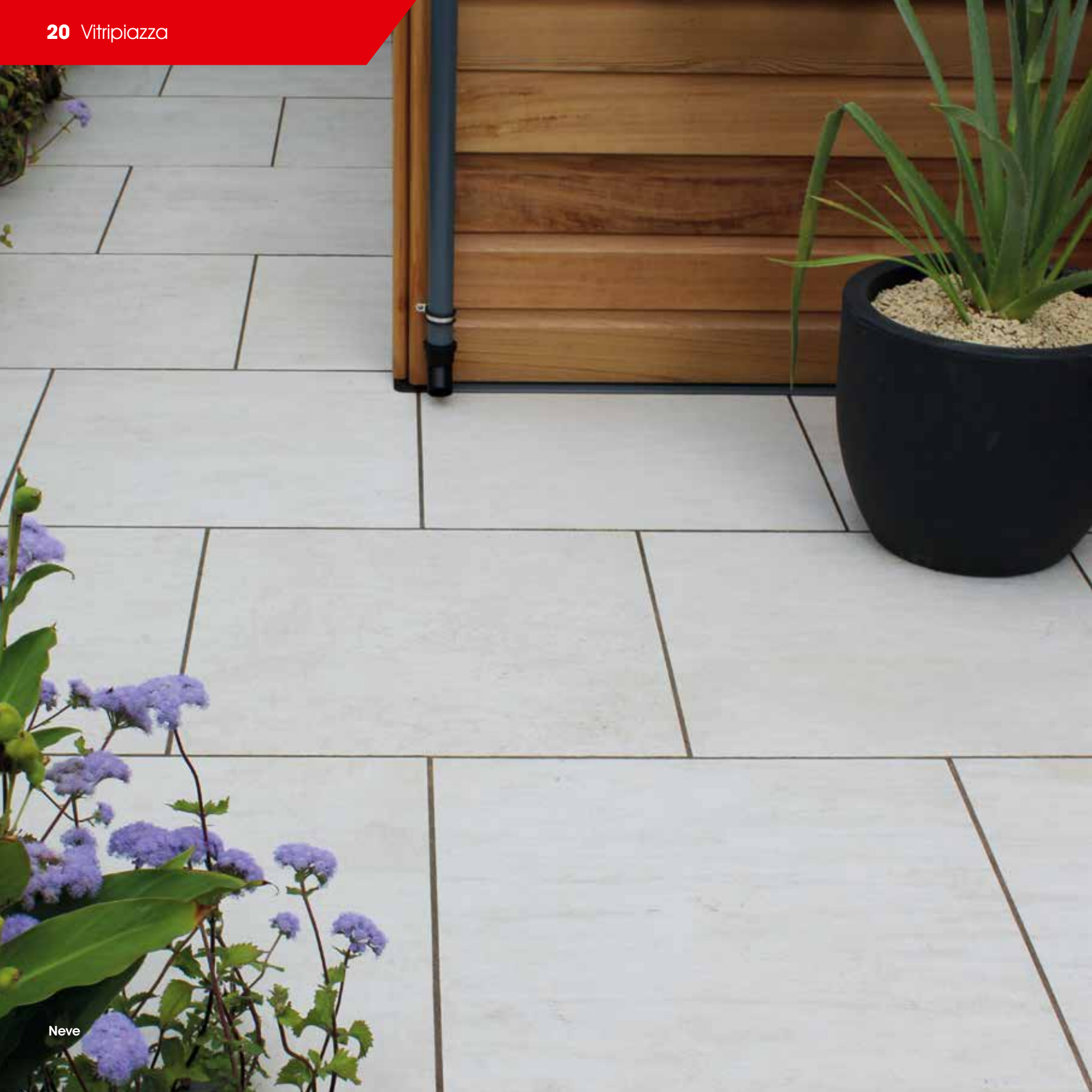

# Moderno



MADE IN ITALY

Moderno is a range that offers a modern, high quality yet economical product. A slightly textured city living 'painted concrete' look in a choice of 3 colours.



Neve

Mercurio

Caramello

Product - External Use	Thickness (mm)	Nominal weight per pack (kg)	Nominal coverage per pack (m <sup>2</sup> )	Number of pieces per pack
600 x 600mm Single Size	20	1010	21.6	60



Please note that the external use 600 x 600mm single size flagstones are also available to order in packs of 2.

Neve



Pallido

# Albero



MADE IN ITALY

The Albero range has been designed to create a natural timber feel, in a choice of 2 beautiful colour options in a plank format.

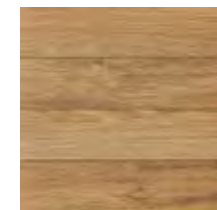

Pallido

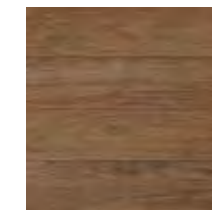

Boschetto

	Thickness (mm)	Nominal weight per pack (kg)	Nominal coverage per pack (m <sup>2</sup> )	Number of pieces per pack
<b>Product - External Use</b>				
1200 x 300mm Single Size	20	528	11.52	32
<b>Product - Internal Use*</b>				
1500 x 250mm Single Size	10	792	33.75	90
900 x 150mm Single Size	10	963	43.74	324

\*All internal use, 10mm thick tiles can be ordered in bespoke pack sizes to suit any size project. Please allow a minimum of 2 - 3 weeks for these to be delivered into your stockist.

Please note that the external use 1200 x 300mm single size pieces are available to order as individual pieces.

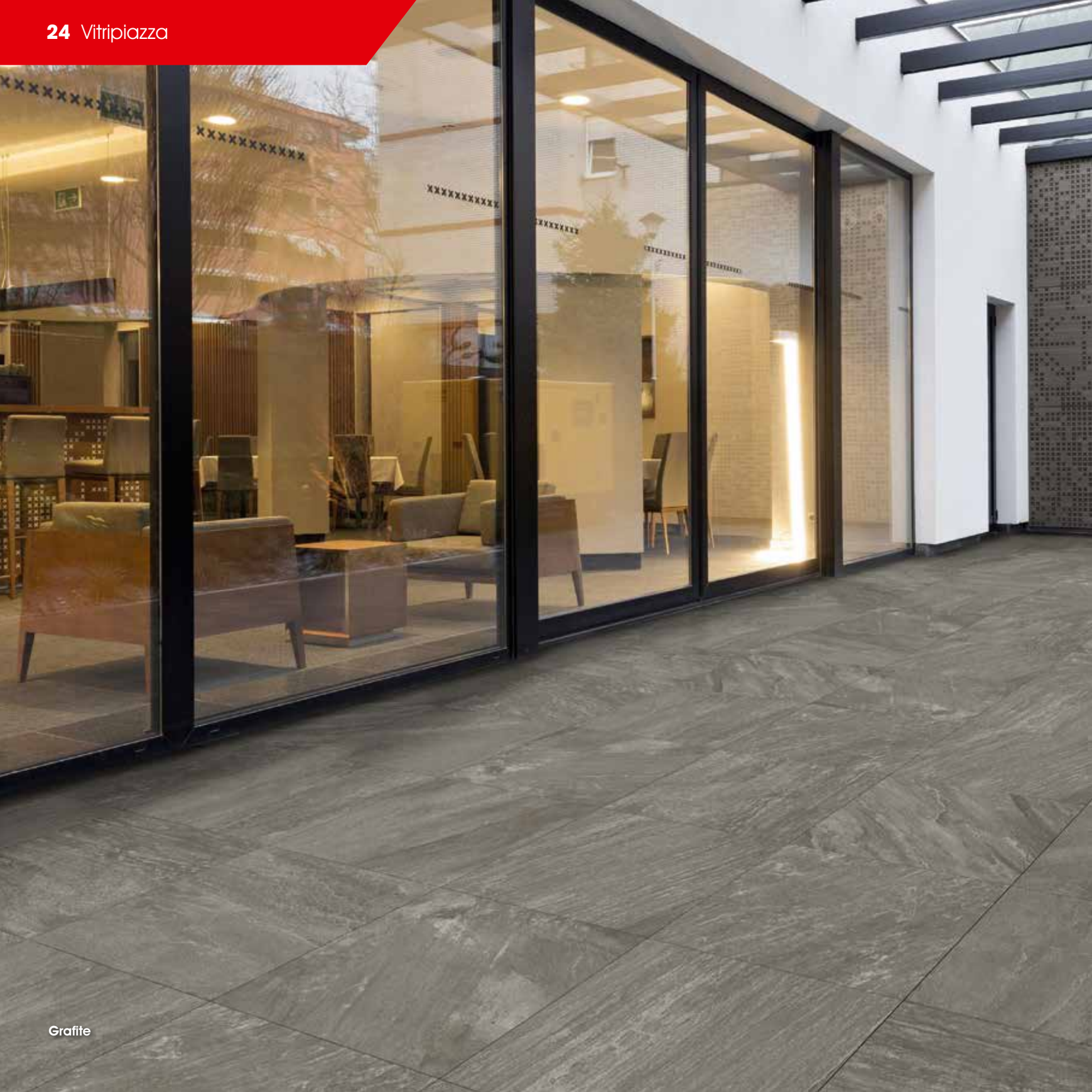

# Anno



MADE IN ITALY

The Anno range offers 6 beautiful colours each with a natural stone finish. Each product features stunning shade variations, offering a unique and distinct finish every time.

Whilst still a high quality porcelain the Anno range offers an economical option for projects with a modest budget.

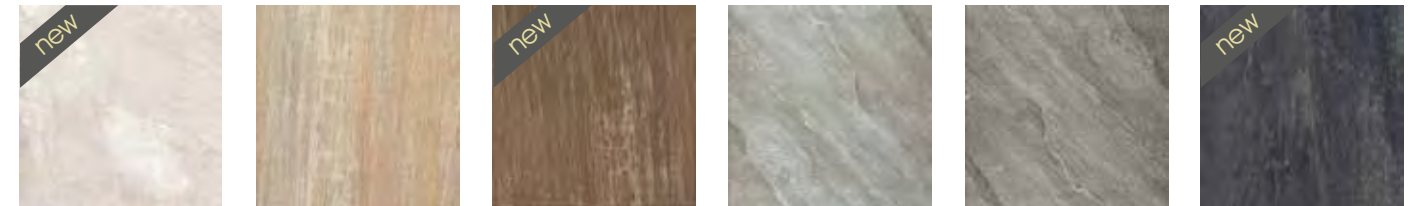

**Avorio      Biscotto      Bronzo      Grigio      Grafite      Pantera**

Product - External Use	Thickness (mm)	Nominal weight per pack (kg)	Nominal coverage per pack (m <sup>2</sup> )	Number of pieces per pack
600 x 600mm Single Size	18	938	23.04	64



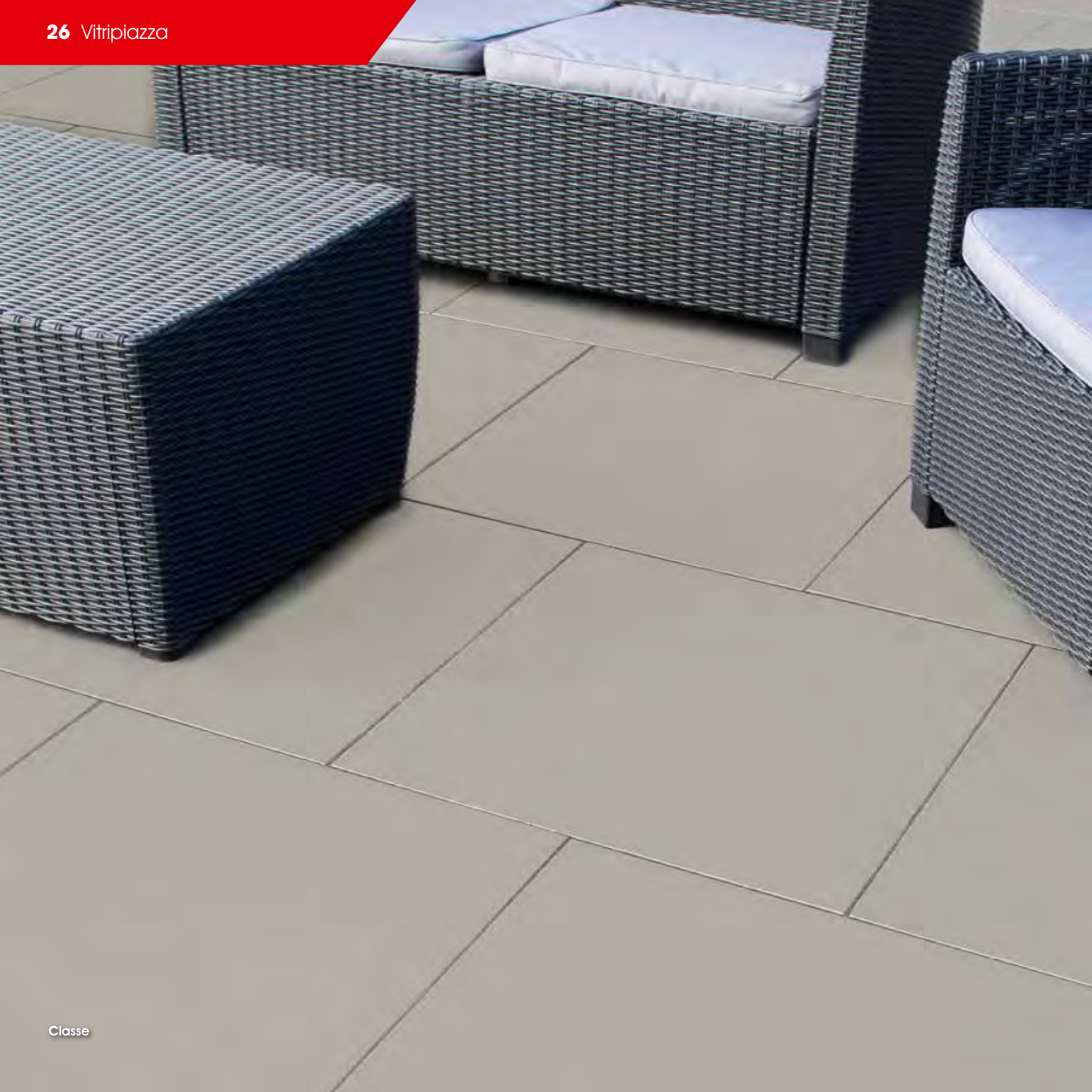

# Stile



MADE IN ITALY

The new Stile range offers a chic and smooth porcelain option that is available in a choice of 3 colours. This simple yet elegant flagstone creates a minimalist feel for contemporary designs.



**Moda**

**Elegante**

**Classe**

	Thickness (mm)	Nominal weight per pack (kg)	Nominal coverage per pack (m <sup>2</sup> )	Number of pieces per pack
<b>Product - External Use</b>				
600 x 600mm Single Size	20	1010	21.6	60
<b>Product - Internal Use*</b>				
600 x 600mm Single Size	10	1080	43.2	120

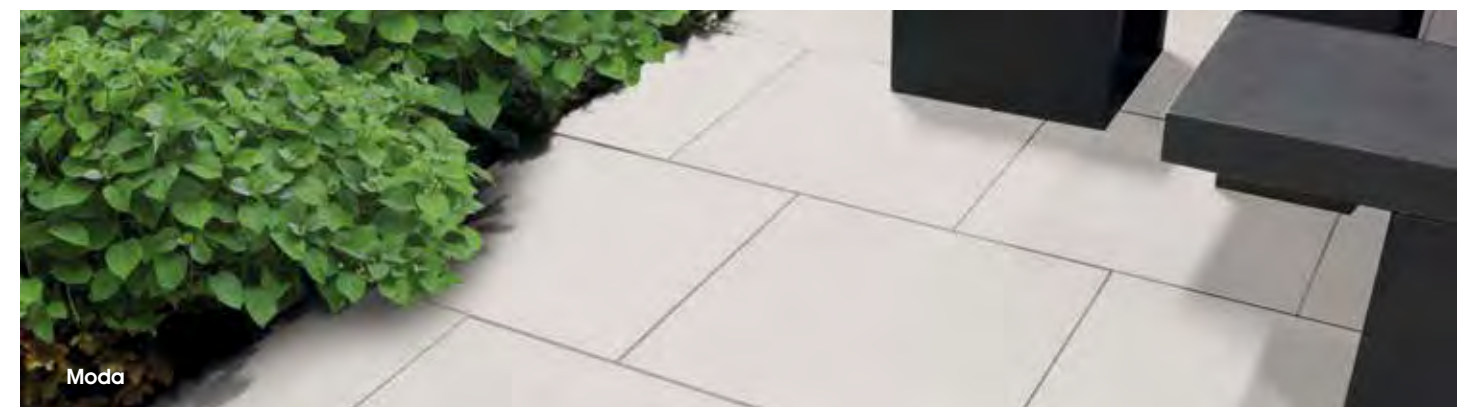

**Moda**

\*All internal use, 10mm thick tiles can be ordered in bespoke pack sizes to suit any size project. Please allow a minimum of 2 - 3 weeks for these to be delivered into your stockist.

Please note that the external use 600 x 600mm single size flagstones are also available to order in packs of 2.

# Accessories and bespoke service

MADE IN ITALY

The accessories range offers everything you may need to naturally create a unique and bespoke outdoor living space, including circle kits, pieces for steps, swimming pools and edgings.

We also offer a unique service in that we can edge process and fabricate bespoke individual pieces of Vitripiazza in any of our colour options, to complement your design and project. Options include: bullnose, half bullnose, chamfered, beveled, over edges and many more.

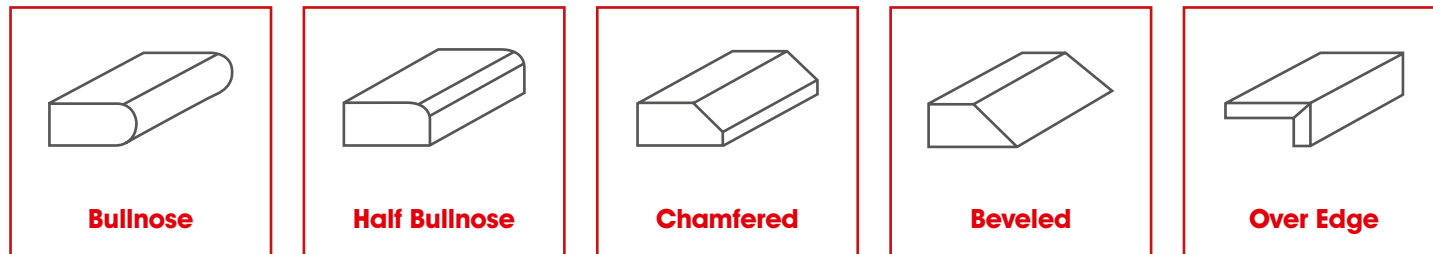

**Bullnose**



**Step Pieces**

If you would like further information about the accessories and/or have any bespoke special order requirements, please contact our Technical Support Office on **0330 333 8030**.  
Please refer to the website [www.vitripiazza.co.uk](http://www.vitripiazza.co.uk) for more details on our full accessory range. Please allow a minimum of 4-6 weeks for special orders to be delivered into your stockist.

## Circles

The Vitripiazza circles are created from flagstones that are 20mm thick and contain a centre piece, 2 rings and a squaring off kit. Each circle kit pack:

- ✔ Covers 5.02m<sup>2</sup>
- ✔ Contains 35 pieces
- ✔ Weighs 250kg

Circles are available in the following colours:

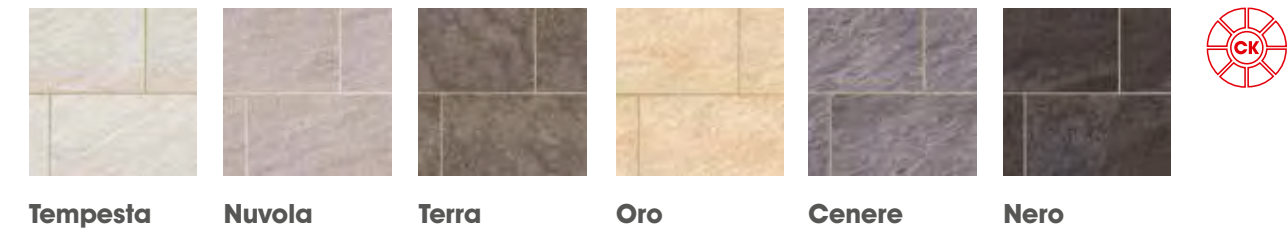

**Circle Kit**

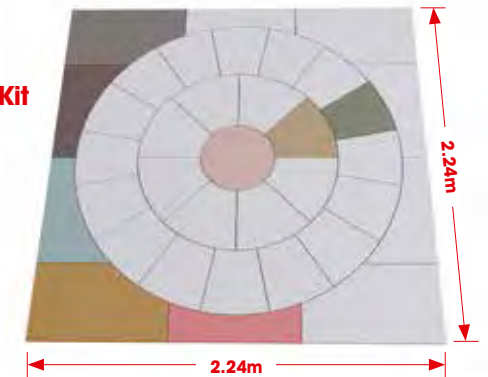

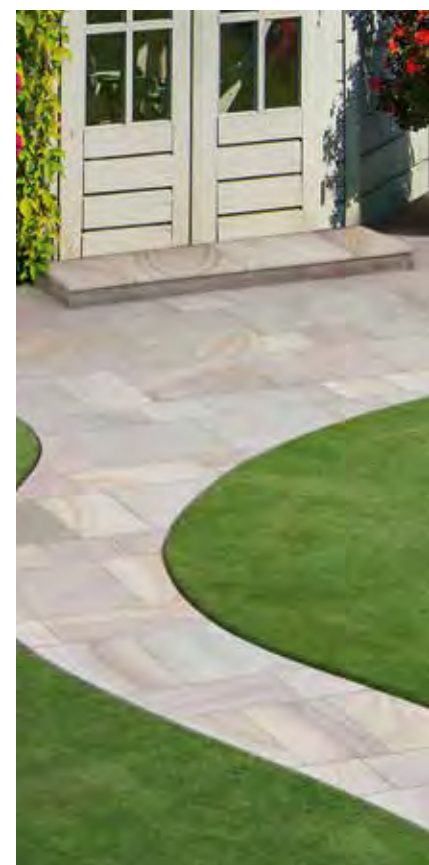



# The Natural Paving collection

The Natural Paving collection offers an extensive range of natural stone flagstones (**Premiastone**, **Cragstone**, **Classicstone**), block paving (**Fossestone**), cobbles (**Cobblestone**), walling (**Cottagestone**) and accessories. With a wide choice in colour, finish and style, there is something to suit every project, home and budget.

Natural stone products are uniquely formed through geological processes, making each piece of stone characteristically subject to colour variations, veining, markings and occasional charming imperfections. As no 2 pieces are identical, natural stone products offer home owners a truly bespoke landscaping option.



**David Richardson**  
Technical Committee Chairman  
of the Stone Federation and Natural  
Stone Consultant at the FMDC

## Our Stone Standard: aiding customer choice

**Our Stone Standard (developed in partnership with David Richardson) is based on testing results which are carried out as part of our compliance with the CE Regulations and show the performance of our sandstone flagstones and block paving products against 3 key criteria: Water Absorption; Flexural Strength and; Frost Resistance. With a simple visual grading system, the Stone Standard enables home owners to understand the performance of the stone and therefore help to select the most suitable product for their purpose.**

### Water Absorption

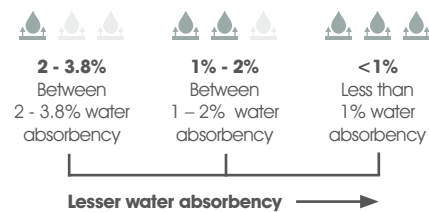

Sandstones with a higher water absorption have the tendency to go green. To help prevent this we recommend sealing with one of the Pavetuf Sealants.

### Flexural Strength

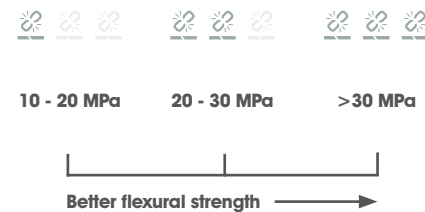

The flexural strength of a stone gives an indication of how strong the stone is. The flexural strength is measured in megapascals (MPa). The higher the number, the less chance it has of failing or delaminating once in-situ.

### Frost Resistance

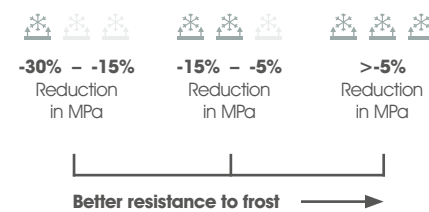

Frost can sometimes attack stone, but most are very resistant to it. We measure this by testing the flexural strength of stones after a cycle of freezing and thawing a batch of samples. We have graded our stones on the percentage difference between the maximum flexural strength test before freezing and the strength test after a repeated freezing. Stones that are not acceptable for the UK market do not appear in our collection.

**Please note: Our Stone Standard is applied to all Natural Paving sandstone flagstones and block paving.**

## Key terms glossary

<b>Flamed</b>	Undergoes a flaming process to give a slight texture and enriched surface colour.
<b>Sawn</b>	Cut to give a smooth, straight surface/edge.
<b>Honed</b>	Lightly polished to give a smooth finish.
<b>Tumbled/Rumbled</b>	Literally tumbled to give a weathered, aged, antique finish.
<b>Beveled</b>	Where a stone edge has been cut at a slight angle, also referred to as a chamfered edge.
<b>Calibrated</b>	Stone that has been machine cut to give a consistent, nominal thickness. Calibrated stone is useful where weight and/or limited depth for laying the product is an issue. It is easier to install than non calibrated stone and gives an ideal finish for internal use.
<b>Hand Cut</b>	Stone that has been hand split and left natural, leaving a flagstone that will vary in thickness. Hand cut stone is an economical option and provides a more traditional finish with greater variance in the riven surface.

<b>Project Packs</b> 	Contain a mixture of various sized flagstones, commonly used to create random patterns.  Linear project packs create linear effect random patterns.
<b>Mixed Packs</b> 	Contain a mixture of various sized stone pieces, used to create a random effect.
<b>Single Sizes</b> 	Contain pieces of stone that are all 1 size, which are fantastic for creating a contemporary look.
<b>Circle Kits</b> 	Contain pieces of flagstones that have been cut and shaped to make circular patterns, ideal for creating focal points.

Please note: All product sizes stated throughout this brochure are nominal and subject to tolerance.

## Benefits of natural stone over concrete: Superior quality, beauty and longevity

**The prominence of natural stone landscaping products over concrete equivalents is unrivalled in that it provides a more beautiful and sustainable option.**

Unlike man-made products, stone is a truly natural product simply taken from the ground and processed using low energy machinery, as opposed to needing high energy, fuel-burning processes that pump vast amounts of CO<sub>2</sub> into the atmosphere, as there is when making concrete products.

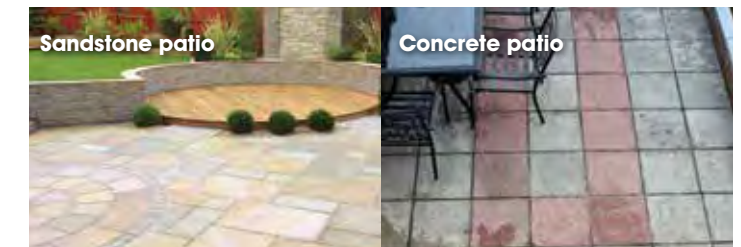
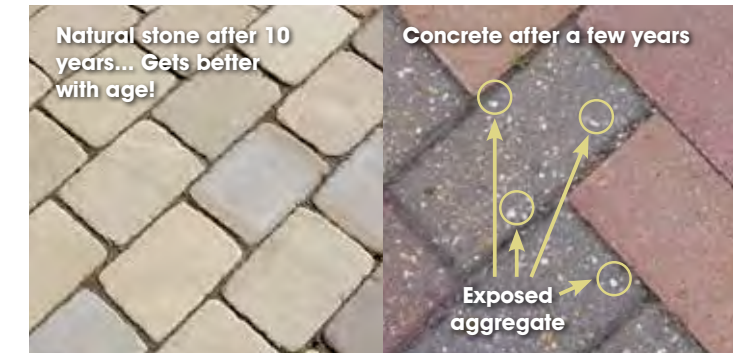

# Premiastone

The Premiastone collection offers flagstones that have been machine cut to give a contemporary, smooth or lightly textured 'squared edge' look. The collection also includes on trend grande and linear sizes.



Ivory

Premiastone flagstones are available in a combination of single sizes and project packs and in a large range of varying colours from warm pinks, cool creams and subtle greys, through to deep classic blacks. With so many options it is difficult to choose a favourite, however you can be sure that whichever makes its way to your garden, it will create a natural 'wow factor'.

Please note that all product sizes, weights and coverages, stated throughout this brochure are nominal.

## The Premiastone collection includes:

### Textured Finish



pg 36  
**Birch**



pg 38  
**Noir Gold**

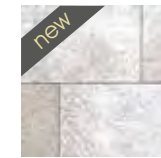

pg 40  
**Silver Ash**



pg 42  
**Copper Slate**



pg 44  
**Black Slate**



pg 46  
**Cedar**



pg 48  
**Pumice**



pg 50  
**Cornsilk**

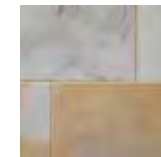

pg 52  
**York Mix**

### Smooth Finish



pg 54  
**Platinum**



pg 56  
**Maple**



pg 58  
**Rydal**



pg 60  
**Ivory**

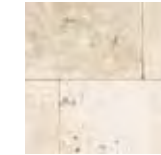

pg 62  
**Cream**

For more product images and laying patterns, please visit [www.naturalpaving.co.uk](http://www.naturalpaving.co.uk) where you can also download the 'Understanding and Installing Natural Stone Guide' for information on installation and how to get the best from your natural stone products.





Patio is edged with Midnight Blue multi kerbs (see page 135) and Midnight Blue block paving (see page 114)

# Birch



Birch is a granite product that undergoes a 'flaming' process, to enrich the colour of the flagstone and create a lightly textured surface. Birch is ideal for creating light and modern outdoor family spaces.

Birch is also available in block paving, see page 116.

Please note that the image on the left shows various sizes of flagstones, some of which the installers have cut down from the 900 x 600mm flagstones.

Product	Thickness (mm)	Nominal weight per pack (kg)	Nominal coverage per pack (m <sup>2</sup> )	Number of pieces per pack
900 x 600mm Calibrated Single Size	20	1100	18	32
900 x 300mm Calibrated Single Size	20	900	14	50





# Noir Gold



Noir Gold is a dark flamed granite, rich in colour with a subtle gold sparkle and lightly textured surface. The straight cut edges give a contemporary feel to this glistening product which creates a real wow factor for outdoor entertaining.

Product	Thickness (mm)	Nominal weight per pack (kg)	Nominal coverage per pack (m <sup>2</sup> )	Number of pieces per pack
900 x 600mm Calibrated Single Size	20	1100	18	32
900 x 300mm Calibrated Single Size	20	900	14	50





# Silver Ash

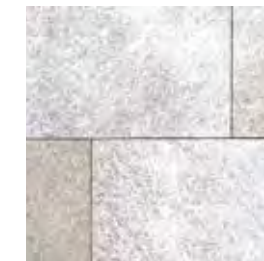

Silver Ash is a lightly flamed granite. A durable and strong product, Silver Ash features silver, black and white shades, ideal for creating a modern and uplifting outdoor living space.

Please note that the image shows various sizes of flagstones, some of which the installers have cut down from the 900 x 600mm flagstones.

Product	Thickness (mm)	Nominal weight per pack (kg)	Nominal coverage per pack (m <sup>2</sup> )	Number of pieces per pack
900 x 600mm Calibrated Single Size	20	1100	18	32
900 x 300mm Calibrated Single Size	20	900	14	50





# Copper Slate



This slate is naturally split to reveal a gently riven surface and has sawn smooth edges that maintain a modern twist on a rustic multi-tonal flagstone.

Product	Thickness (mm)	Nominal weight per pack (kg)	Nominal coverage per pack (m <sup>2</sup> )	Number of pieces per pack		
				600mm x 600mm	600mm x 295mm	295mm x 295mm
Calibrated Project Pack	20	925	18.8	24	35	34

Please note that sizes are nominal





**DESIGN IDEA**  
 This product has also been used for the treads and risers on the steps

# Black Slate



This dark slate is a naturally split stone, that has a gently riven surface. It's sawn smooth edges complement the textured surface to maintain a modern feel. Brown, buff and gold markings can naturally occur and appear on this dark base.

Product	Thickness (mm)	Nominal weight per pack (kg)	Nominal coverage per pack (m <sup>2</sup> )	Number of pieces per pack		
				Please note that sizes are nominal		
				600mm x 600mm	600mm x 295mm	295mm x 295mm
Calibrated Project Pack	20	925	18.8	24	35	34

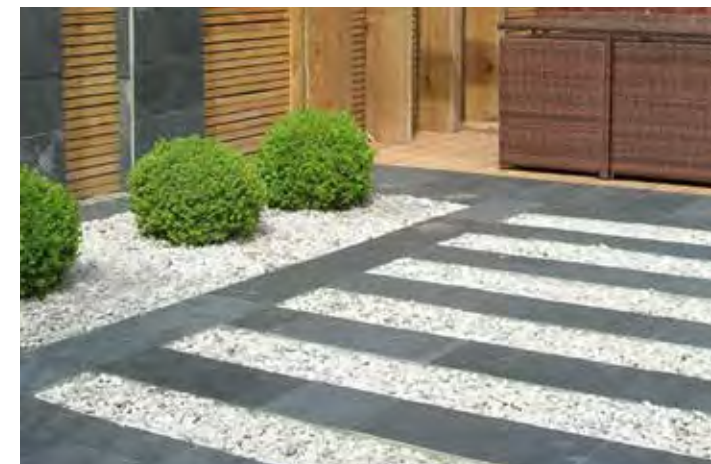



# Cedar



- Water Absorbency
- Flexural Strength
- Freeze-Thaw Test

Cedar is a sandstone with sawn, smooth edges which enable clean lines to create a contemporary pattern. The delicately textured surface is light in colour, ideal for creating a feeling of enhanced space in smaller areas.

Product	Thickness (mm)	Nominal weight per pack (kg)	Nominal coverage per pack (m <sup>2</sup> )	Number of pieces per pack
900 x 600mm Calibrated Single Size	20	1100	18	32







# Pumice



- Water Absorbency
- Flexural Strength
- Freeze-Thaw Test

With a lightly textured surface, Pumice is a sandstone product with sawn cut, smooth sleek edges. Pumice's grey base can sometimes weather to reveal brown and buff tones.

Pumice is also available in a bullnose coping that can be used on walls, steps and pool edges, to enable continuity of colour throughout outdoor living spaces, see page 133 for details.

Product	Thickness (mm)	Nominal weight per pack (kg)	Nominal coverage per pack (m <sup>2</sup> )	Number of pieces per pack
900 x 600mm Calibrated Single Size	20	1100	18	32



Paving has been jointed using the grey Pavetuf Jointing Compound



See page 155 Pavetuf



# Cornsilk

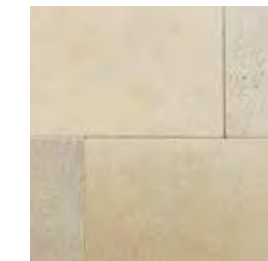

Water Absorbency 

Flexural Strength 

Freeze-Thaw Test 

Cornsilk is a gently coloured and lightly textured sandstone. Available in a single size, Cornsilk comes with modern sawn, smooth cut edges.

Cornsilk is also available in a bullnose coping that can be used on walls, steps and pool edges, to enable continuity of colour throughout various garden designs, see page 133 for details.

Please note that the image shows various sizes of flagstones, some of which the installers have cut down from the 900 x 600mm flagstones.

Product	Thickness (mm)	Nominal weight per pack (kg)	Nominal coverage per pack (m <sup>2</sup> )	Number of pieces per pack
900 x 600mm Calibrated Single Size	20	1100	18	32



Please note this product is shown wet.



# York Mix



- Water Absorbency
- Flexural Strength
- Freeze-Thaw Test

York Mix is a sawn cut sandstone with clean edges and a slightly textured surface. Available in single size packs, York Mix reflects a look, similar to the popular 'York Stone'.

With a striking mix of buff and grey coloured flagstones, all packs should be opened and pieces mixed before installation, to prevent colour banding and to ensure the desired dual colour pattern that York Mix offers is achieved. Please note that some flags will be a mix of buff and grey whilst others can be all grey or all buff tones.

York Mix is also available in block paving, see page 108 for details.

Product	Thickness (mm)	Nominal weight per pack (kg)	Nominal coverage per pack (m <sup>2</sup> )	Number of pieces per pack
900 x 600mm Calibrated Single Size	20	1100	18	32



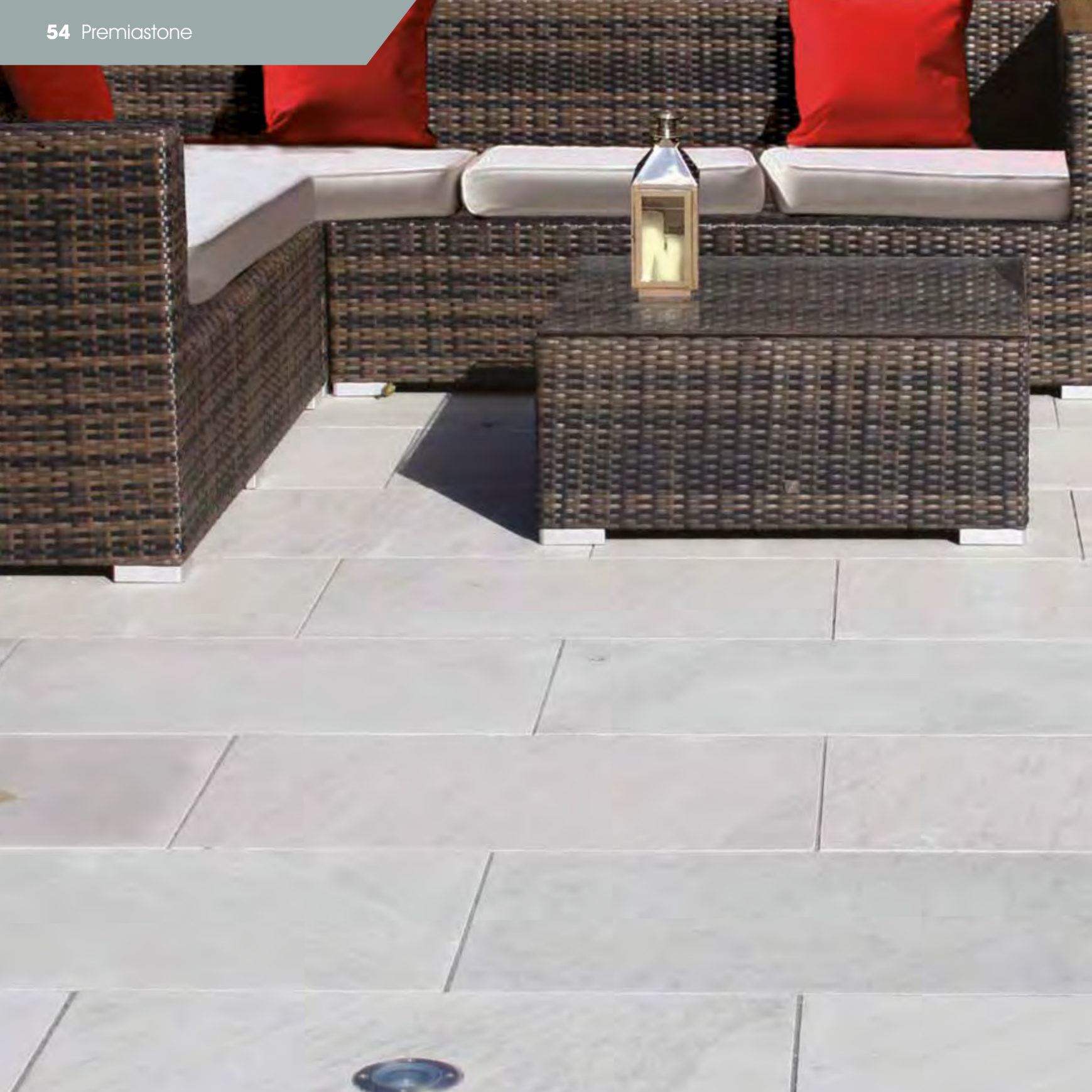

# Platinum

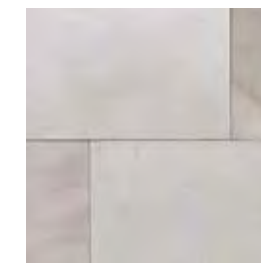

Water Absorbency

Flexural Strength

Freeze-Thaw Test

Platinum is a sandstone that has been sawn to create squared cut edges and honed to give a smooth surface finish. Platinum's grey palette can weather to reveal brown and buff tones.

Platinum is available in the very current linear format, designed to create sleek, clean lines and a feeling of length, see image below. Platinum is also available in other single sizes and a linear project pack.

Product - Project Packs	Thickness (mm)	Nominal weight per pack (kg)	Nominal coverage per pack (m <sup>2</sup> )	Number of pieces per pack		
				Please note that sizes are nominal		
				600mm x 600mm	600mm x 300mm	300mm x 300mm
Calibrated Linear Project Pack	20	1100	19.46	24	35	34
Product - Single Sizes				1200mm x 600mm	1200mm x 150mm	900mm x 600mm
1200 x 600mm Grande Calibrated Single Size	25	950	14.4	20	-	-
1200 x 150mm Linear Calibrated Single Size	25	720	12	-	66	-
900 x 600mm Calibrated Single Size	20	1100	18	-	-	32





# Maple



- Water Absorbency
- Flexural Strength
- Freeze-Thaw Test

Maple is a sandstone with sawn cut edges and a honed surface, that reveals a beautiful natural vein effect. Maple is available in the contemporary grande and linear size options. The image below shows how both sizes can be combined to create a contemporary look. Maple is also available in a smaller single size and a modern linear project pack option, as shown in the image to the left.

Maple has a beautiful and varied colour palette, with each shade differing in strength of colour and tone. Some pieces also carry a distinctive veining. In order to achieve the desired colour pattern and prevent colour banding all packs should be opened and pieces mixed before installation.

Product - Project Pack	Thickness (mm)	Nominal weight per pack (kg)	Nominal coverage per pack (m <sup>2</sup> )	Number of pieces per pack <small>Please note that sizes are nominal</small>		
				600mm x 600mm	600mm x 300mm	300mm x 300mm
Calibrated Linear Project Pack	20	1100	19.46	24	35	34
Product - Single Size				1200mm x 600mm	1200mm x 150mm	900mm x 600mm
1200 x 600mm Grande Calibrated Single Size	25	950	14.4	20	-	-
1200 x 150mm Linear Calibrated Single Size	25	720	12	-	66	-
900 x 600mm Calibrated Single Size	20	1100	18	-	-	32



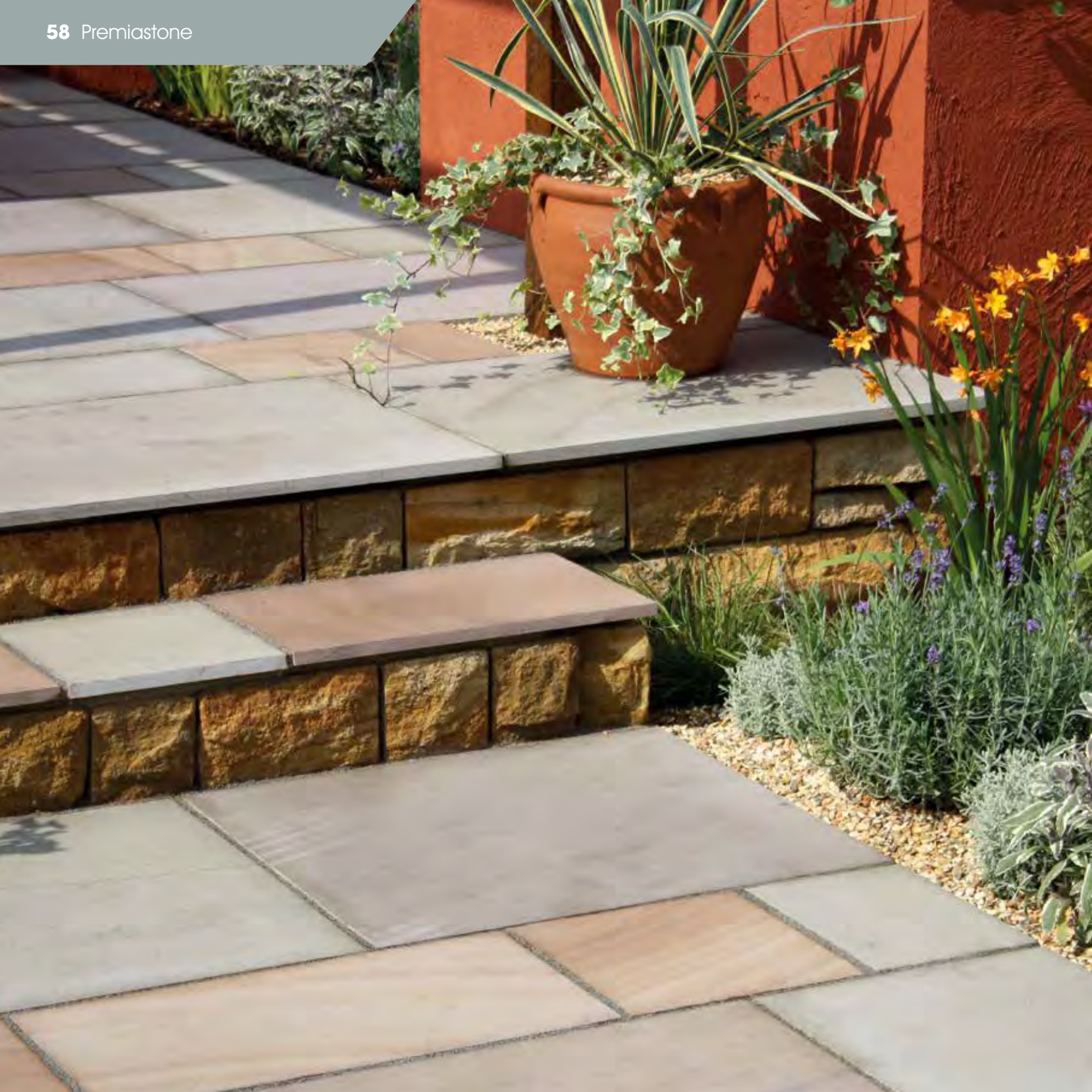

# Rydal



- Water Absorbency
- Flexural Strength
- Freeze-Thaw Test

A sandstone with a mix of calm tones, Rydal sits well next to a vast range of colours and within many settings, from smaller courtyard spaces through to larger open patio areas. With a smooth, honed surface and clean squared edges, Rydal is available in a contemporary linear style project pack and a single size option.



Product	Thickness (mm)	Nominal weight per pack (kg)	Nominal coverage per pack (m <sup>2</sup> )	Number of pieces per pack			
				Please note that sizes are nominal			
				900mm x 600mm	600mm x 600mm	600mm x 300mm	300mm x 300mm
Calibrated Linear Project Pack	20	1100	19.46	-	24	35	34
900 x 600mm Calibrated Single Size	20	1100	18	32	-	-	-





# Ivory



- Water Absorbency 
- Flexural Strength 
- Freeze-Thaw Test 

Ivory is a smooth sandstone, with a light and modern colour palette. Available in a unique project pack, Ivory flagstones have sawn and smooth cut edges.

Product	Thickness (mm)	Nominal weight per pack (kg)	Nominal coverage per pack (m <sup>2</sup> )	Number of pieces per pack <small>Please note that sizes are nominal</small>	
				600mm x 400mm	400mm x 400mm
Calibrated Project Pack	20	1050	20.36	50	50



Please note image shows the product in wet conditions and some of the larger sizes within the pack have been cut down to create a specific pattern.



# Cream



Cream is a sawn cut travertine which is rumbled to create a slightly weathered and Mediterranean look.

Available in a project pack, Cream travertine brings a warmth to all outdoor living spaces from country courtyards through to city terraces.

Product	Thickness (mm)	Nominal weight per pack (kg)	Nominal coverage per pack (m <sup>2</sup> )	Number of pieces per pack			
				Please note that sizes are nominal			
				610mm x 406mm	406mm x 406mm	406mm x 203mm	203mm x 203mm
Calibrated Project Pack	30	1200	15	18	36	29	51

Please note the image below right shows all 610 x 406mm pieces, which have been selected from the project pack by the installer.



Patio is edged with Pewter cobbles (see page 125)



# Cragstone

The Cragstone collection offers a select range of weathered flagstones, full of inspired antique charm.

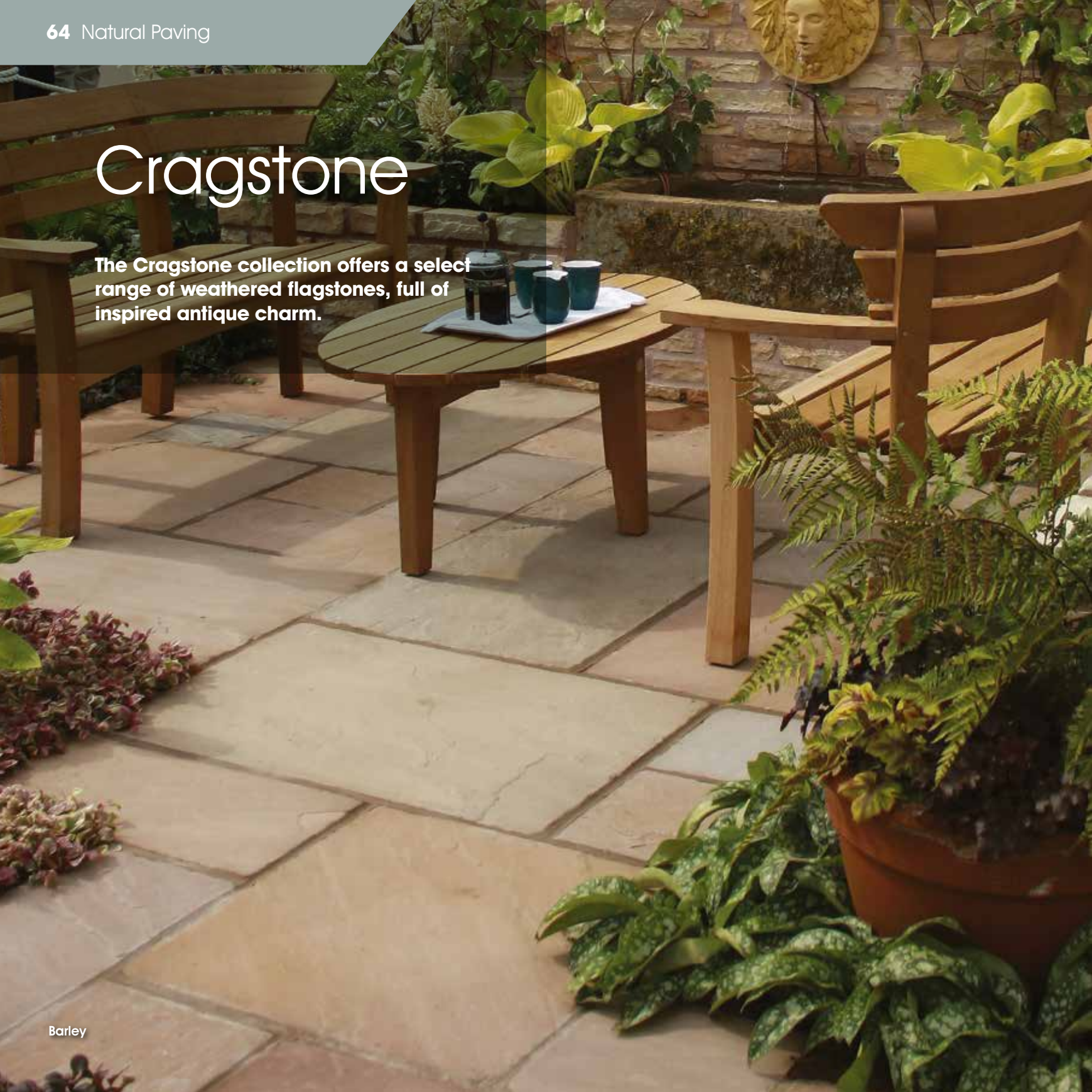

Barley

Each piece of stone within the Cragstone collection undergoes a weathering process, to create a soft aged finish, ideal for those wanting a traditional flagstone with a smoother feel.

Please note that all product sizes, weights and coverages, stated throughout this brochure are nominal.

Available in calibrated project packs the Cragstone collection includes:



pg 66  
**Tuscan**



pg 68  
**Teal**



pg 70  
**Old York**



pg 72  
**Meadow**



pg 74  
**Barley**

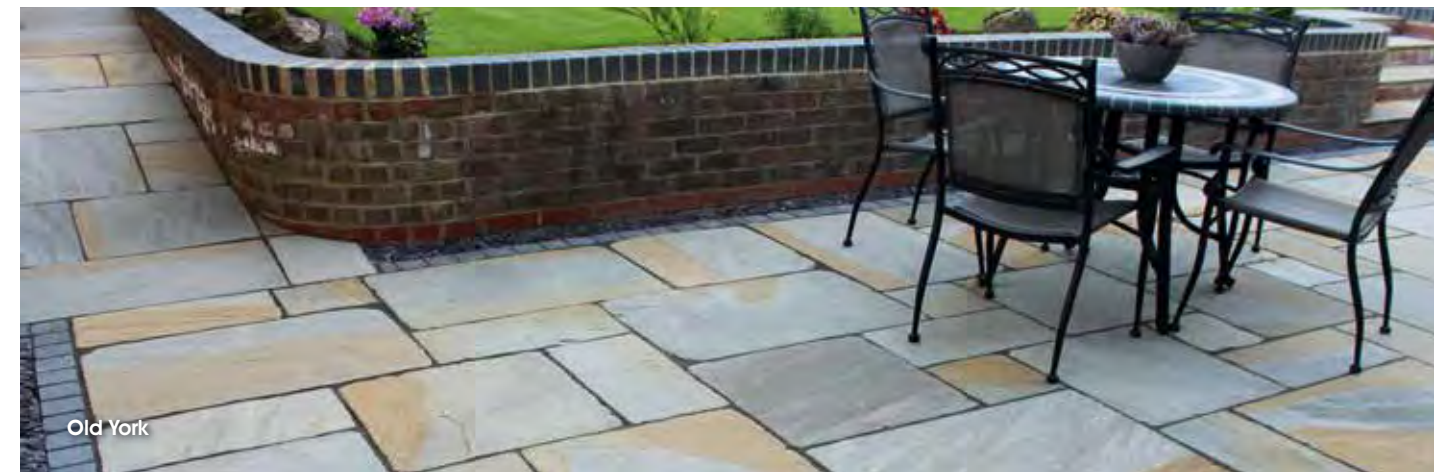

Old York



For more product images and laying patterns please visit [www.naturalpaving.co.uk](http://www.naturalpaving.co.uk) where you can also download the 'Understanding and Installing Natural Stone Guide' for information on installation and how to get the best from your natural stone products.

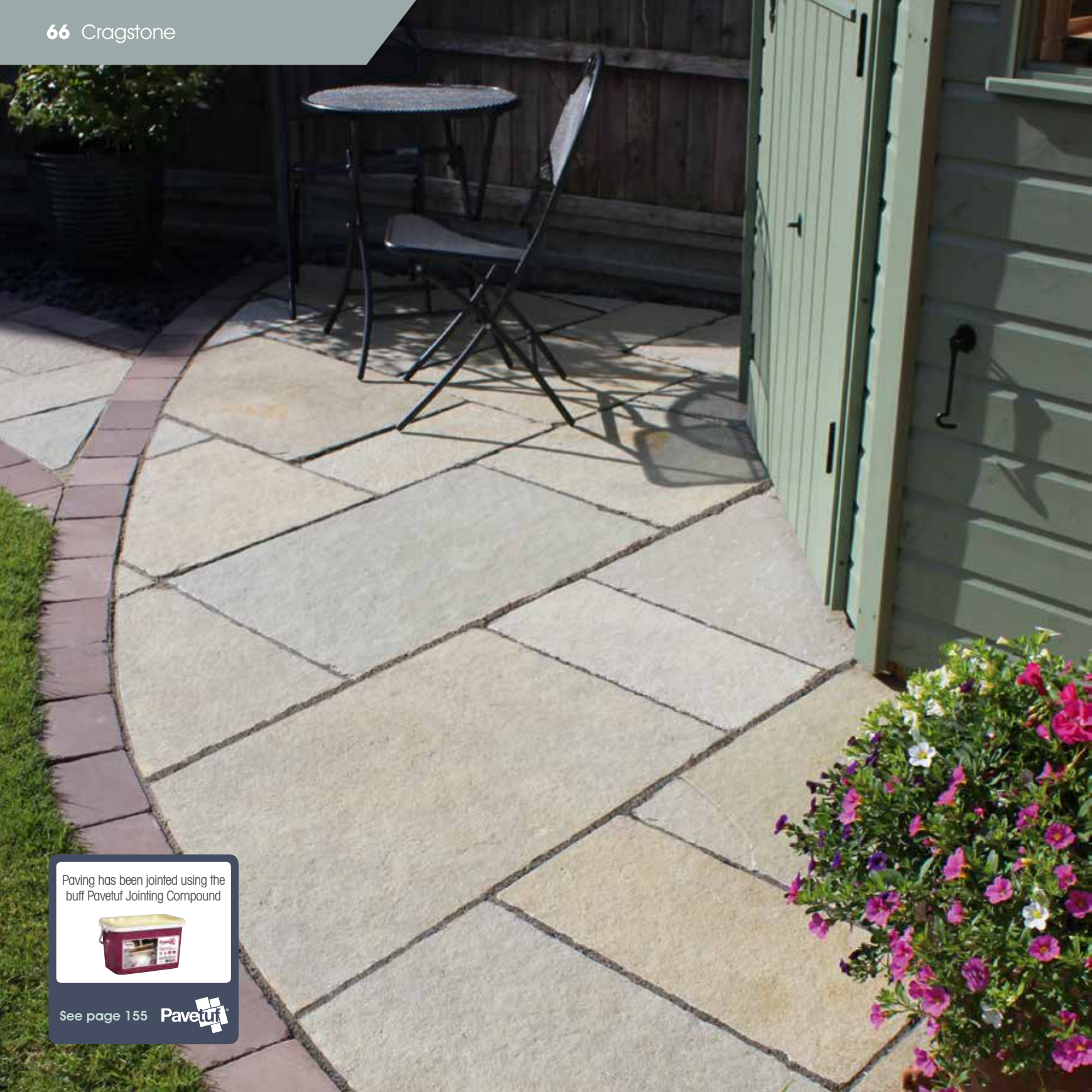

# Tuscan



Tuscan limestone has a subtly weathered surface and matching edges, with a varying colour palette. Rustic and occasional imperfect corners only add to Tuscan's charming character.

As Tuscan is a limestone, it may naturally lighten over time.

Product	Thickness (mm)	Nominal weight per pack (kg)	Nominal coverage per pack (m <sup>2</sup> )	Number of pieces per pack			
				Please note that sizes are nominal			
				900mm x 600mm	600mm x 600mm	600mm x 290mm	290mm x 290mm
Calibrated Project Pack	24	950	18.9	16	16	16	12

Paving has been jointed using the buff Pavetuf Jointing Compound



See page 155 





# Teal



Teal is a weathered limestone, with a smoother, less riven finish than its sandstone counterparts within this collection. As Teal is a limestone, it may naturally lighten over time.

Product	Thickness (mm)	Nominal weight per pack (kg)	Nominal coverage per pack (m <sup>2</sup> )	Number of pieces per pack			
				Please note that sizes are nominal			
				900mm x 600mm	600mm x 600mm	600mm x 290mm	290mm x 290mm
Calibrated Project Pack	24	950	18.9	16	16	16	12



Paving has been jointed using the grey Pavetuf Jointing Compound



See page 155 **Pavetuf**



Patio edged with ebony cobbles see page 125

# Old York



- Water Absorbency
- Flexural Strength
- Freeze-Thaw Test

Old York has the colouring of the distinctive 'York Stone' and is a rumbled sandstone, which creates a charming old world finish.



Product	Thickness (mm)	Nominal weight per pack (kg)	Nominal coverage per pack (m <sup>2</sup> )	Number of pieces per pack			
				Please note that sizes are nominal			
				900mm x 600mm	600mm x 600mm	600mm x 290mm	290mm x 290mm
Calibrated Project Pack	24	950	18.9	16	16	16	12





# Meadow



- Water Absorbency 
- Flexural Strength 
- Freeze-Thaw Test 

Meadow sandstone has a distinct colourful and weathered profile, creating an antique look.

Meadow is also available in cobbles (see page 125), which are ideal for creating bespoke focal points in Meadow patio areas, as can be seen in the image below, on the left.

Product	Thickness (mm)	Nominal weight per pack (kg)	Nominal coverage per pack (m <sup>2</sup> )	Number of pieces per pack			
				Please note that sizes are nominal			
				900mm x 600mm	600mm x 600mm	600mm x 290mm	290mm x 290mm
Calibrated Project Pack	24	950	18.9	16	16	16	12



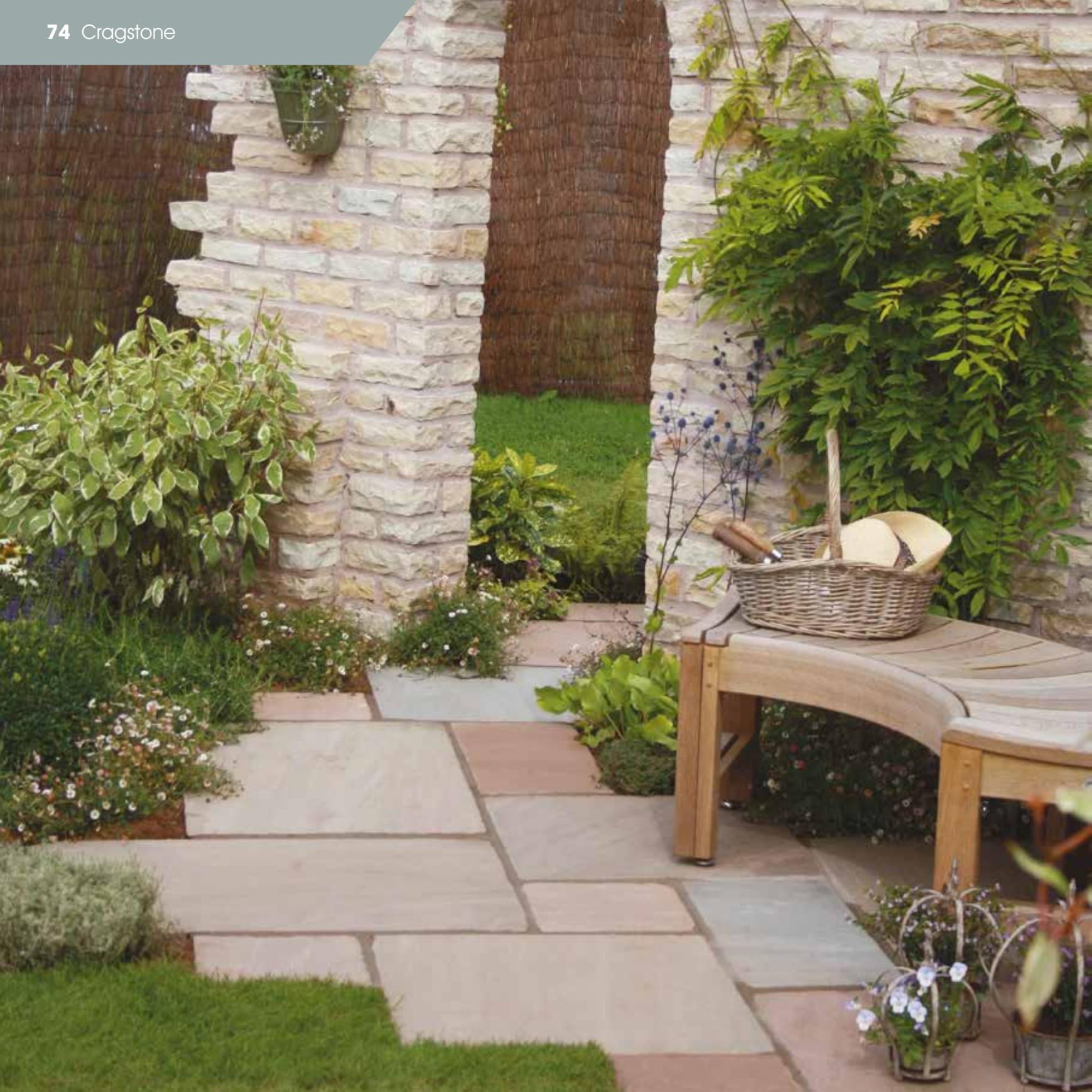

# Barley



Water Absorbency 

Flexural Strength 

Freeze-Thaw Test 

Barley is a weathered sandstone with a softly riven surface and worn edges. With rich colours, this rustic flagstone is available in a traditional project pack.

Product	Thickness (mm)	Nominal weight per pack (kg)	Nominal coverage per pack (m <sup>2</sup> )	Number of pieces per pack			
				Please note that sizes are nominal			
				900mm x 600mm	600mm x 600mm	600mm x 290mm	290mm x 290mm
Calibrated Project Pack	24	950	18.9	16	16	16	12



# Classicstone

**Classicstone is exactly what it suggests, the ultimate in timeless, traditional flagstones. Each hand cut piece has a naturally riven surface and edges that inspires a warm and natural olde worldie look.**



Promenade

**Each flagstone within this range is distinct with: unique varying colour palettes; differing riven surfaces; natural veining and; occasional fossil prints. The Classicstone products are available in a combination of project packs, single sizes and circle kits.**

Classicstone offers a range of sandstone and limestone products just as nature intended, 'unprocessed' and with a surprisingly economical and equally beautiful price tag.

Please note that all product sizes, weights and coverages, stated throughout this brochure are nominal.

## The Classicstone collection includes:

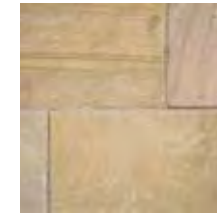

pg 78  
**Harvest**



pg 80  
**Lakeland**



pg 82  
**Golden Fossil**



pg 84  
**Promenade**



pg 86  
**Autumn Brown**



pg 88  
**Heather**

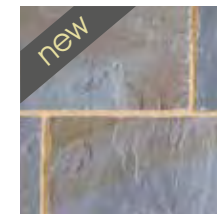

pg 90  
**Yorkshire Blend**



pg 92  
**Graphite**

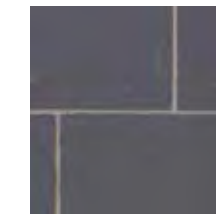

pg 94  
**Carbon Black**



pg 96  
**Steel Blue**



pg 98  
**Classic Circles**

The Classicstone collection offers a range of matching circle kits, designed to enable designers and homeowners to create unique patterns and focal points.



For more product images and laying patterns please visit [www.naturalpaving.co.uk](http://www.naturalpaving.co.uk) where you can also download the 'Understanding and Installing Natural Stone Guide' for information on installation and how to get the best from your natural stone products.

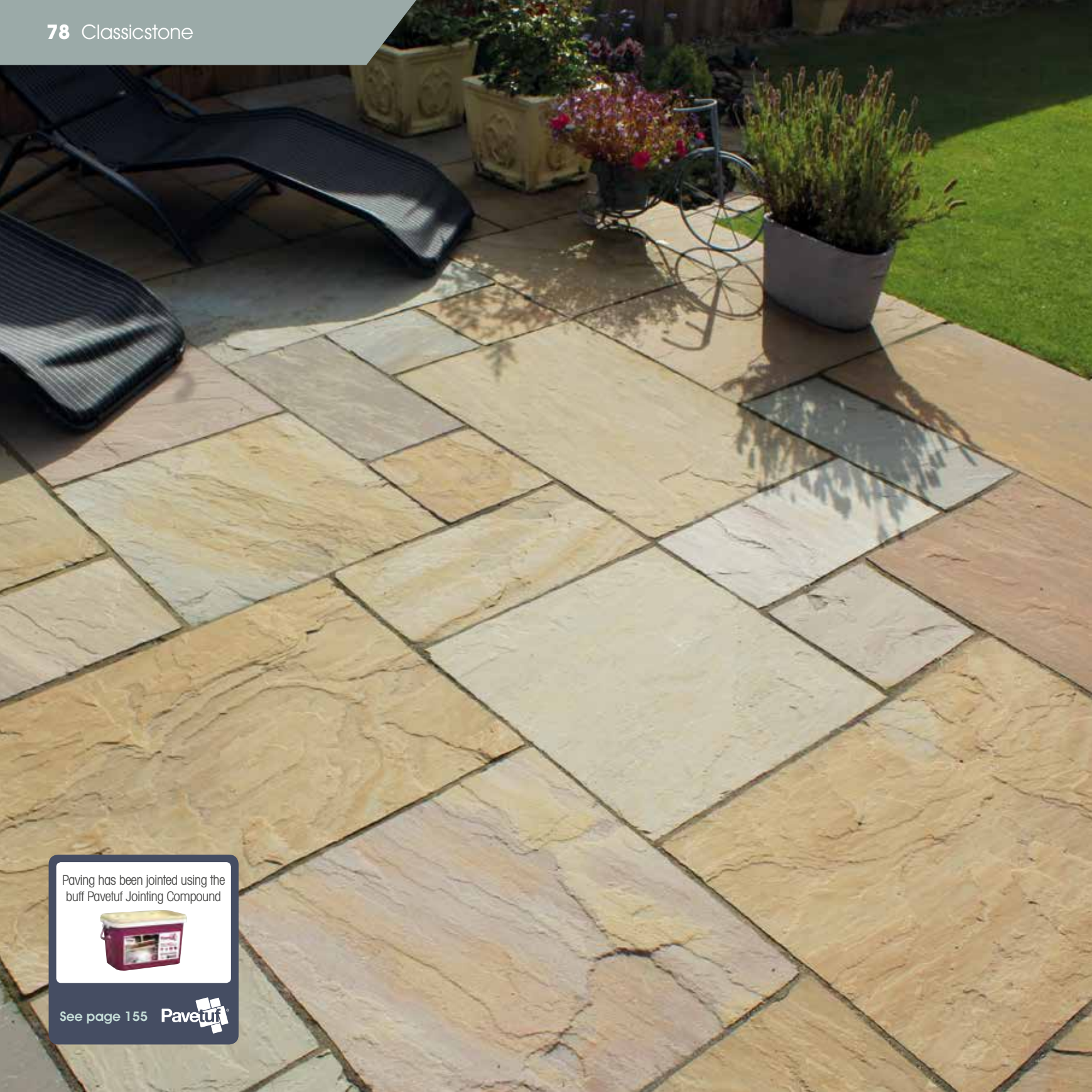

# Harvest



Water Absorbency

Flexural Strength

Freeze-Thaw Test



Harvest is a traditionally riven sandstone, with a variety of colour blends and product sizes, which can accommodate any garden design.

Project packs create a traditional looking patio pattern whilst the single sizes can be used for a more modern effect. Although there is no difference to the surface finish, the finestone option is a thinner, lighter product which lends itself to projects with a modest budget.

Harvest is also available in circle kits (see page 99).

Product	Thickness (mm)	Nominal weight per pack (kg)	Nominal coverage per pack (m <sup>2</sup> )	Number of pieces per pack			
				Please note that sizes are nominal			
				900mm x 600mm	600mm x 600mm	600mm x 290mm	290mm x 290mm
Calibrated Project Pack	24	950	18.9	16	16	16	12
Finestone Project Pack	15 - 22	1150	22.2	17	20	20	18
900 x 600mm Calibrated Single Size	24	925	17.8	33	-	-	-
600 x 600mm Calibrated Single Size	24	825	15.8	-	44	-	-
600 x 290mm Calibrated Single Size	24	925	17.8	-	-	102	-
290 x 290mm Calibrated Single Size	24	1025	19.7	-	-	-	232

Paving has been jointed using the buff Pavetuf Jointing Compound



See page 155





# Lakeland



Water Absorbency

Flexural Strength

Freeze-Thaw Test

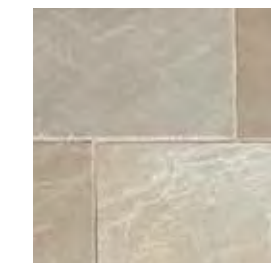

Lakeland sandstone is a best seller from the Classicstone range. Due to its popularity, Lakeland is available in project packs, single sizes, circle kits (see page 99), walling (see page 131), stepping stones (see page 134) and copings (see page 133).

A naturally riven flagstone with soft, natural tones and occasional fossil prints, Lakeland complements all landscapes. With an extensive product range in Lakeland, landscapers and home owners can design a truly unique and co-ordinated outdoor living space that flows with a consistency in colour.

Product	Thickness (mm)	Nominal weight per pack (kg)	Nominal coverage per pack (m <sup>2</sup> )	Number of pieces per pack			
				Please note that sizes are nominal			
				900mm x 600mm	600mm x 600mm	600mm x 290mm	290mm x 290mm
Calibrated Project Pack	24	950	18.9	16	16	16	12
Finestone Project Pack	15 - 22	1150	22.2	17	20	20	18
900 x 600mm Calibrated Single Size	24	925	17.8	33	-	-	-
600 x 600mm Calibrated Single Size	24	825	15.8	-	44	-	-
600 x 290mm Calibrated Single Size	24	925	17.8	-	-	102	-
290 x 290mm Calibrated Single Size	24	1025	19.7	-	-	-	232

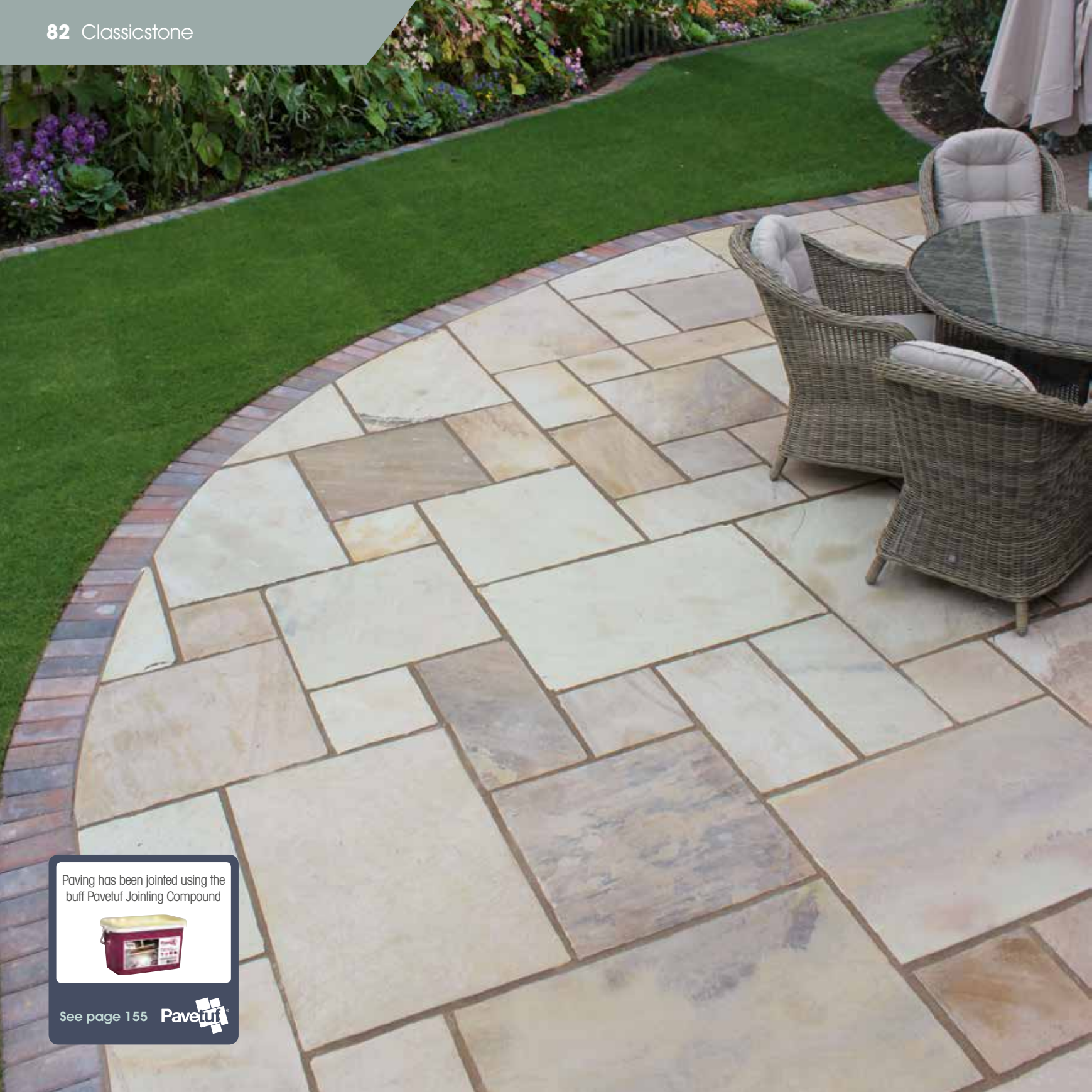

# Golden Fossil



- Water Absorbency
- Flexural Strength
- Freeze-Thaw Test

Golden Fossil is a coarse and riven sandstone that has naturally occurring, random fossil prints.

Golden Fossil is available in project packs and contemporary single sizes and also circle kits (see page 99), walling (see page 131) and wall copings (see page 133).

Product	Thickness (mm)	Nominal weight per pack (kg)	Nominal coverage per pack (m <sup>2</sup> )	Number of pieces per pack			
				Please note that sizes are nominal			
				900mm x 600mm	600mm x 600mm	600mm x 290mm	290mm x 290mm
Calibrated Project Pack	24	950	18.9	16	16	16	12
900 x 600mm Calibrated Single Size	24	925	17.8	33	-	-	-
600 x 600mm Calibrated Single Size	24	825	15.8	-	44	-	-
600 x 290mm Calibrated Single Size	24	925	17.8	-	-	102	-
290 x 290mm Calibrated Single Size	24	1025	19.7	-	-	-	232



Paving has been jointed using the buff Pavetuf Jointing Compound



See page 155



# Promenade



Water Absorbency

Flexural Strength

Freeze-Thaw Test



A classic sandstone with a cool colour palette, Promenade is available in modern single sizes, more traditional project packs and circle kits (see page 99). Predominantly a grey hue, Promenade can weather to expose brown and buff shades.

Although no difference to the surface finish, Promenade is also available in a finestone project pack, which is a thinner, lighter option to the thicker project packs, offering a more practical option for keener budgets.

Product	Thickness (mm)	Nominal weight per pack (kg)	Nominal coverage per pack (m <sup>2</sup> )	Number of pieces per pack			
				900mm x 600mm	600mm x 600mm	600mm x 290mm	290mm x 290mm
Calibrated Project Pack	24	950	18.9	16	16	16	12
Finestone Project Pack	15 - 22	1150	22.2	17	20	20	18
900 x 600mm Calibrated Single Size	24	925	17.8	33	-	-	-
600 x 600mm Calibrated Single Size	24	825	15.8	-	44	-	-
600 x 290mm Calibrated Single Size	24	925	17.8	-	-	102	-
290 x 290mm Calibrated Single Size	24	1025	19.7	-	-	-	232

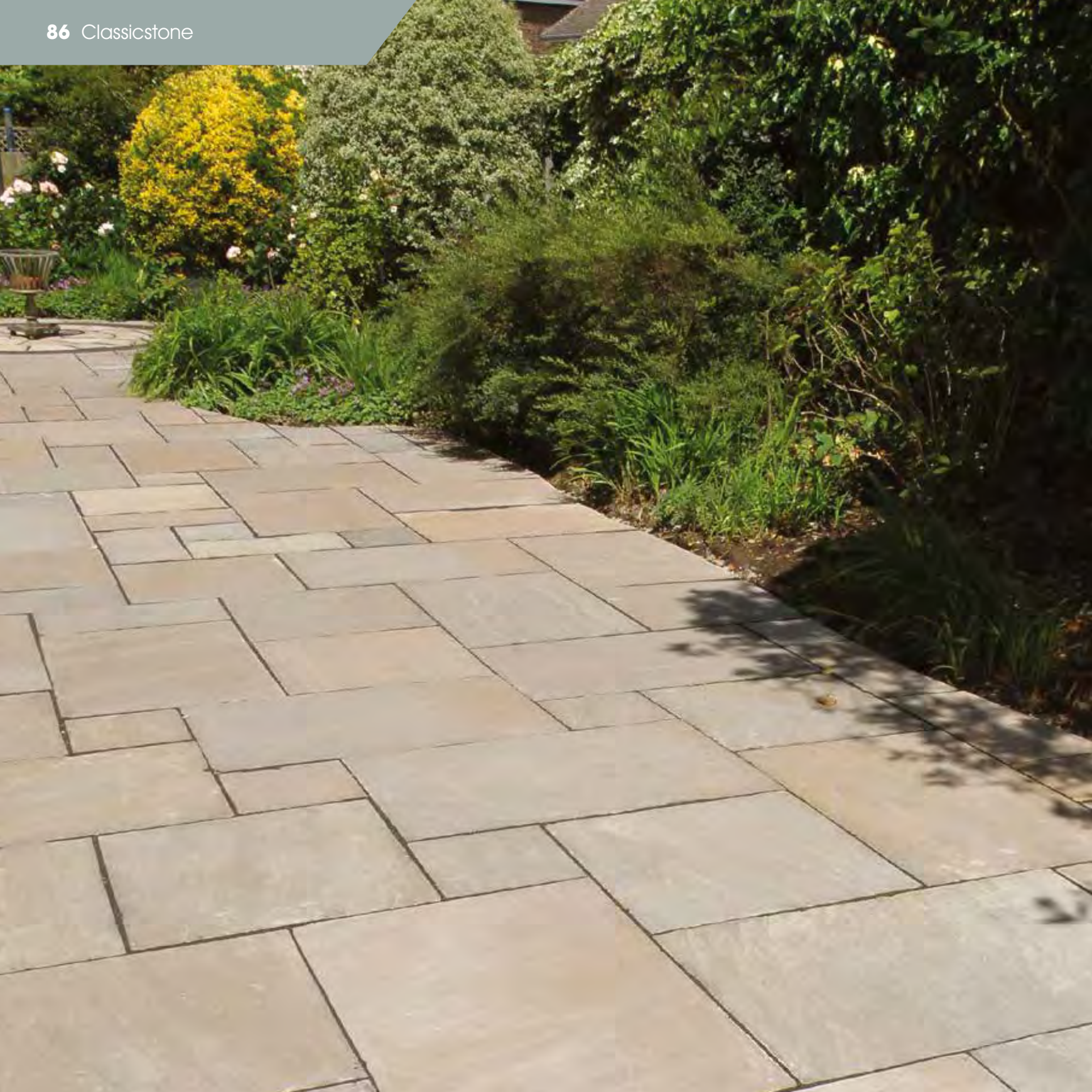

# Autumn Brown

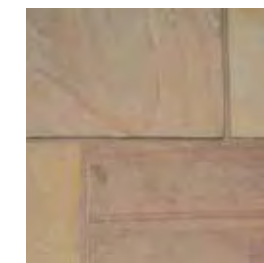

Water Absorbency 

Flexural Strength 

Freeze-Thaw Test 

Autumn Brown is a traditional sandstone with a riven surface and irregular interesting edges. With a warm colour tone, this product is attractive in any space, but lends itself well to a rural scene.

Autumn Brown is available in a calibrated project pack and a more economical finestone option.

Product	Thickness (mm)	Nominal weight per pack (kg)	Nominal coverage per pack (m <sup>2</sup> )	Number of pieces per pack			
				900mm x 600mm	600mm x 600mm	600mm x 290mm	290mm x 290mm
Calibrated Project Pack	24	950	18.9	16	16	16	12
Finestone Project Pack	15 - 22	1150	22.2	17	20	20	18

Please note that sizes are nominal





# Heather

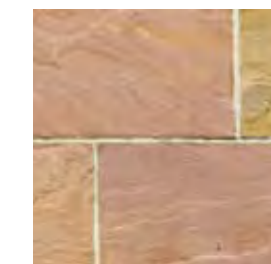

Water Absorbency

Flexural Strength

Freeze-Thaw Test

Heather is a naturally riven sandstone available in a traditional project pack and circle kit (see page 99 for details). With strong attractive colour tones, Heather makes a beautiful addition to any garden.

Please note that the image to the left shows 900 x 600mm flagstones, from the project pack, which the installer has selected for use in the installation.

Product	Thickness (mm)	Nominal weight per pack (kg)	Nominal coverage per pack (m <sup>2</sup> )	Number of pieces per pack			
				Please note that sizes are nominal			
				900mm x 600mm	600mm x 600mm	600mm x 290mm	290mm x 290mm
Calibrated Project Pack	24	950	18.9	16	16	16	12





# Yorkshire Blend

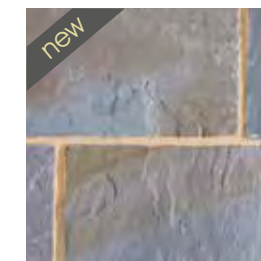

Water Absorbency 

Flexural Strength 

Freeze-Thaw Test 

Yorkshire Blend is a traditional sandstone with a naturally riven finish displaying a similar colour palette to the distinctive 'York Stone' with varying grey and buff blends.

Product	Thickness (mm)	Nominal weight per pack (kg)	Nominal coverage per pack (m <sup>2</sup> )	Number of pieces per pack			
				Please note that sizes are nominal			
				900mm x 600mm	600mm x 600mm	600mm x 290mm	290mm x 290mm
Calibrated Project Pack	24	950	18.9	16	16	16	12





# Graphite



Water Absorbency 

Flexural Strength 

Freeze-Thaw Test 

A chunky sandstone, Graphite has a riven surface of contrasting dark and light shades. A rustic product available in a traditional project pack.

Product	Thickness (mm)	Nominal weight per pack (kg)	Nominal coverage per pack (m <sup>2</sup> )	Number of pieces per pack			
				Please note that sizes are nominal			
				900mm x 600mm	600mm x 600mm	600mm x 290mm	290mm x 290mm
Calibrated Project Pack	24	950	18.9	16	16	16	12



We recommend the grey Pavetuf Jointing Compound to joint this product



See page 155 

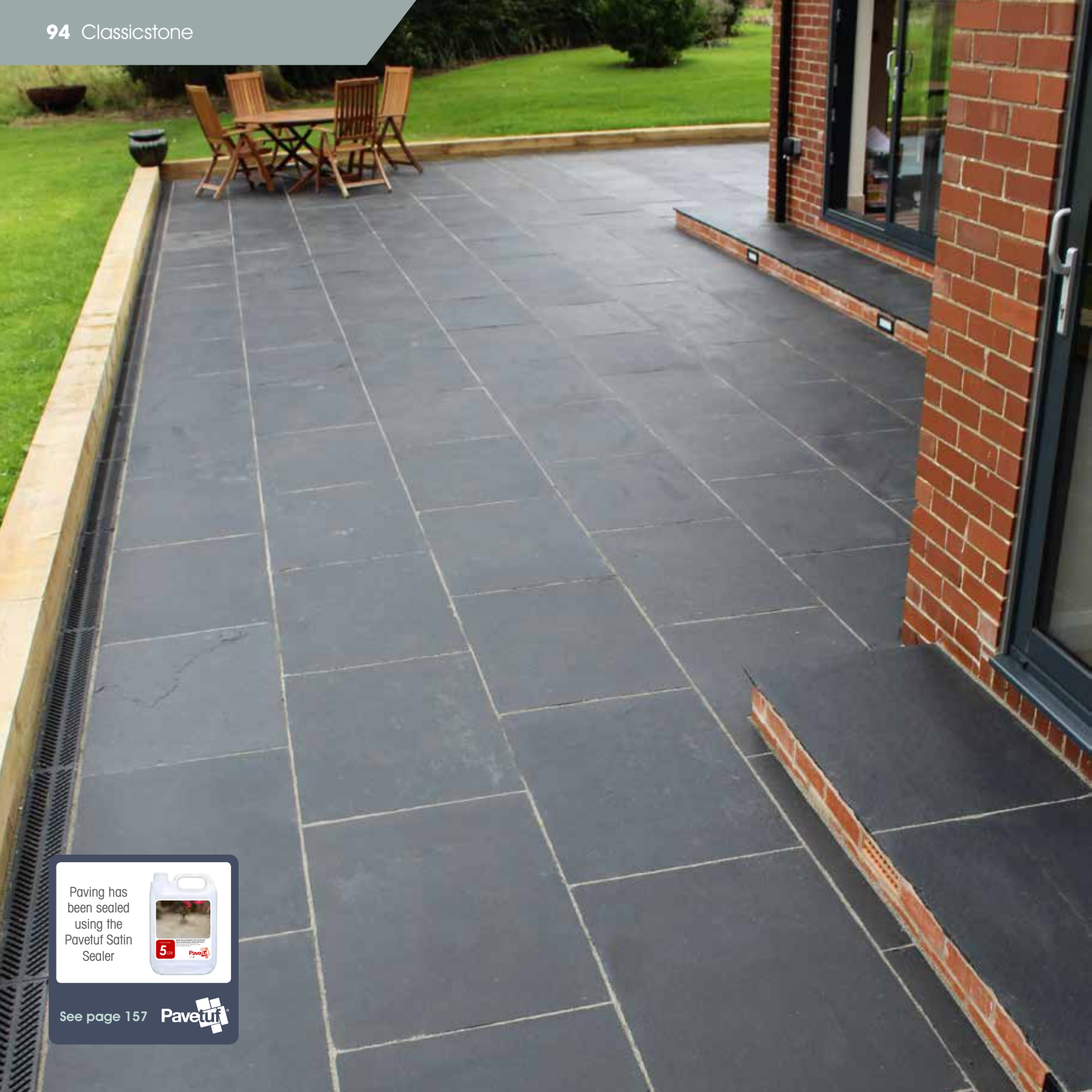

# Carbon Black

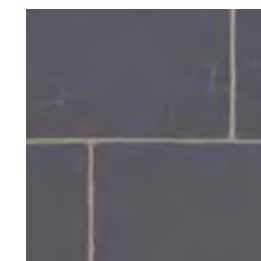

A dark limestone, Carbon Black is a riven hand cut stone. To complete the look, Carbon Black is also available in walling and copings for use with pools, walls and steps, see pages 131 and 133 respectively for details.

As Carbon Black is a limestone, it may naturally lighten over time.

Product	Thickness (mm)	Nominal weight per pack (kg)	Nominal coverage per pack (m <sup>2</sup> )	Number of pieces per pack			
				900mm x 600mm	600mm x 600mm	600mm x 290mm	290mm x 290mm
Hand Cut Project Pack	20 - 30	1100	15.25	13	13	13	9
900 x 600mm Hand Cut Single Size	20 - 30	1150	15.1	28	-	-	-
600 x 600mm Hand Cut Single Size	20 - 30	1150	15.1	-	42	-	-
600 x 290mm Hand Cut Single Size	20 - 30	1225	16	-	-	92	-

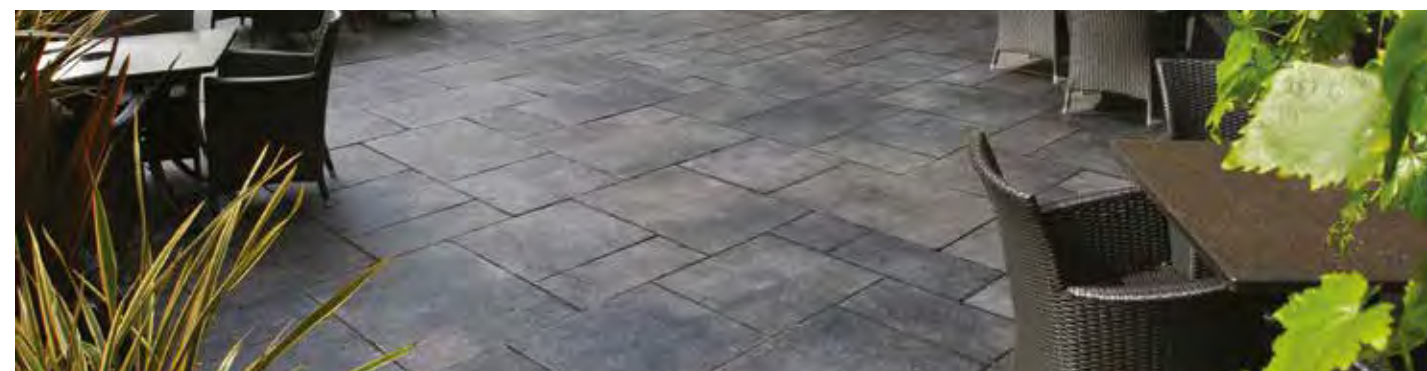

Paving has been sealed using the Pavetuf Satin Sealer



See page 157 



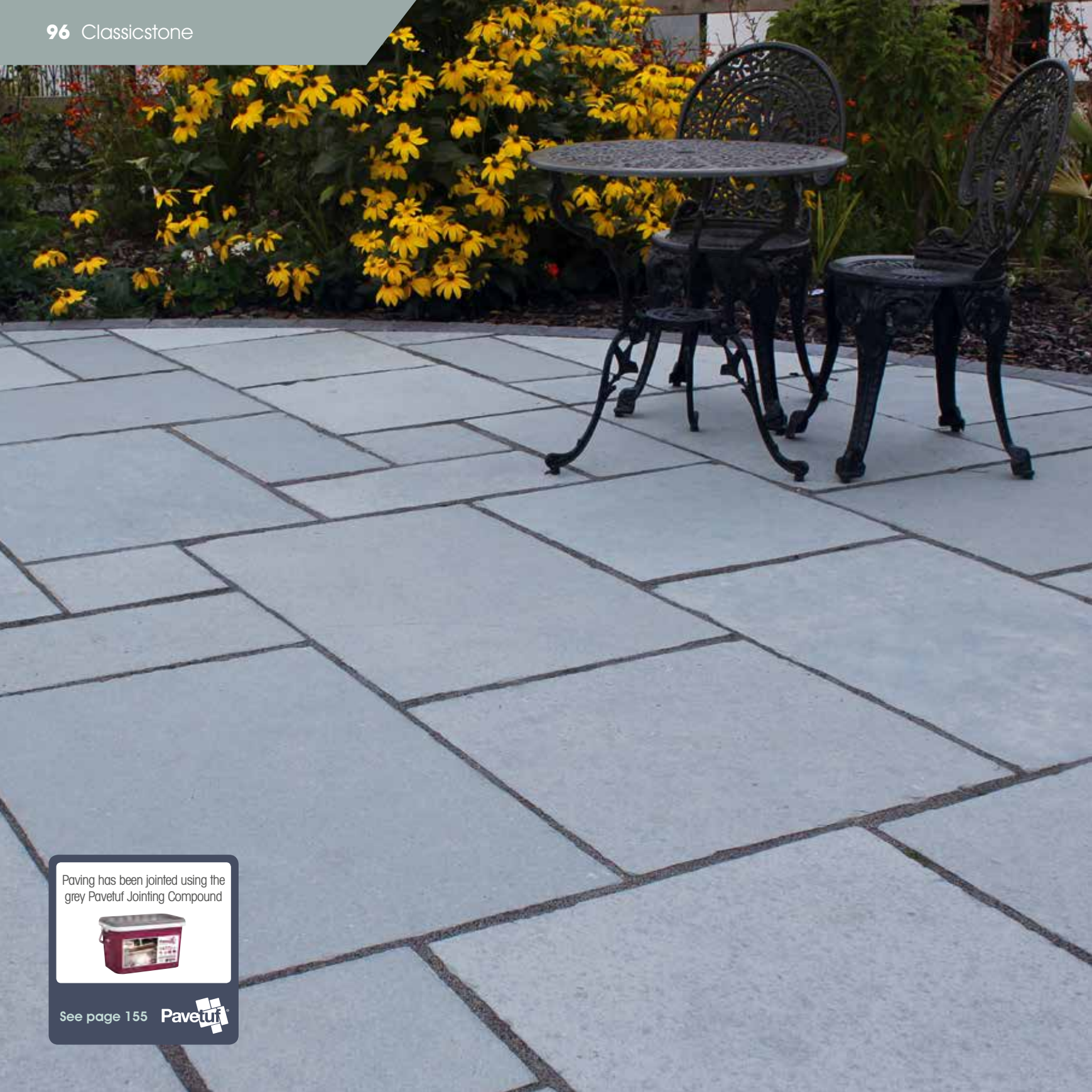

# Steel Blue



Steel Blue is a traditional hand cut limestone, with a riven surface and weathered edges.

As with all limestone products, Steel Blue may naturally lighten over time.

Product	Thickness (mm)	Nominal weight per pack (kg)	Nominal coverage per pack (m <sup>2</sup> )	Number of pieces per pack			
				Please note that sizes are nominal			
				900mm x 600mm	600mm x 600mm	600mm x 290mm	290mm x 290mm
Hand Cut Project Pack	20 - 30	1100	15.25	13	13	13	9



Paving has been jointed using the grey Pavetuf Jointing Compound



See page 155 

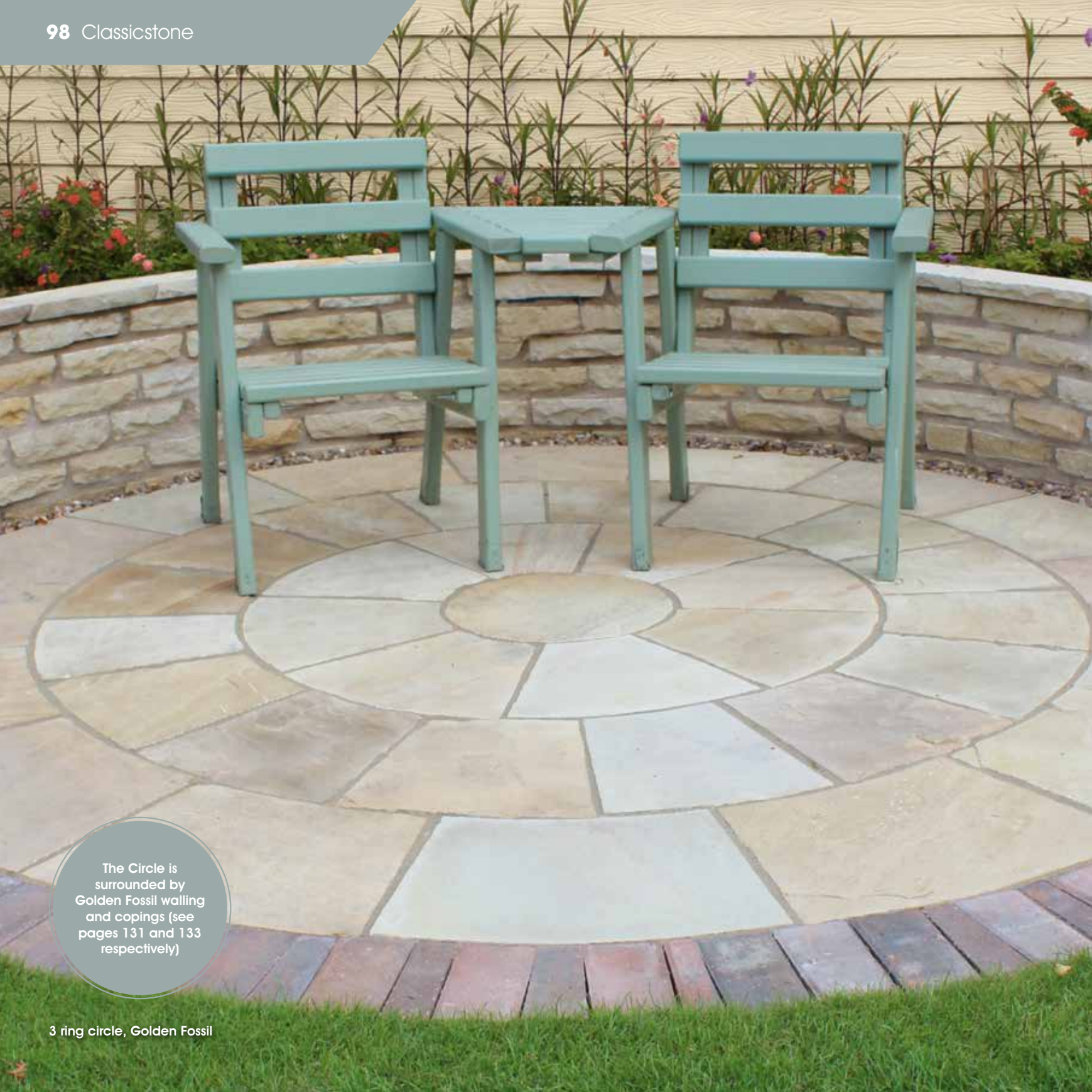

The Circle is surrounded by Golden Fossil walling and copings (see pages 131 and 133 respectively)

3 ring circle, Golden Fossil

# Classic Circles

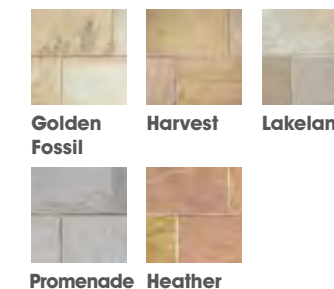

Available in a variety of sizes, circles fashion interesting features and create focal points in larger spaces. The circle kits are available in most of the sandstone colours within the Classicstone range including Golden Fossil, Harvest, Lakeland, Promenade and Heather.

### Colours Available

Product	Golden Fossil	Harvest	Lakeland	Promenade	Heather
4 ring circle	-	✓	✓	-	-
3 ring circle with squaring off kit	✓	✓	✓	✓	✓
3 ring circle	✓	✓	✓	✓	✓
2 ring circle with squaring off kit	✓	✓	✓	✓	✓

Please note there may be colour/shade variations between circle kits and their corresponding flagstones.

<p>4 ring circle</p> <p>3.7m diameter</p> <p>Each 4 ring circle:                  - Covers 10.75m<sup>2</sup>                  - Contains 57 pieces                  - Weighs 575kg</p>	<p>3 ring circle with squaring off kit</p> <p>3m</p> <p>Each 3 ring circle with squaring off kit:                  - Covers 9m<sup>2</sup>                  - Contains 61 pieces                  - Weighs 475kg</p>	<p>3 ring circle</p> <p>2.8m diameter</p> <p>Each 3 ring circle:                  - Covers 6.2m<sup>2</sup>                  - Contains 41 pieces                  - Weighs 350kg</p>	<p>2 ring circle with squaring off kit</p> <p>2.4m</p> <p>Each 2 ring circle with squaring off kit:                  - Covers 5.8m<sup>2</sup>                  - Contains 45 pieces                  - Weighs 325kg</p>
---	--	---	--



Maple



Corn silk (wet)



Lakeland



Harvest

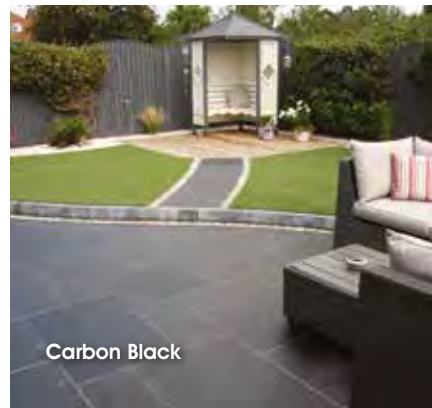

Carbon Black



Harvest with Circle

# Installation

If you are looking for help with the design and/or installation of your paving, you can find a list of Landscaping Professionals on our website [www.naturalpaving.co.uk/landscaping-professionals](http://www.naturalpaving.co.uk/landscaping-professionals)

For information regarding installation you can refer to our 'Understanding and Installing Natural Stone Paving' guide and there are also many independent sources of further detailed advice available, for example The Paving Expert [www.pavingexpert.com](http://www.pavingexpert.com)



Download our 'Understanding and Installing Natural Stone Paving' guide for further details on how to carefully install your paving for best results, as incorrect installation methods can lead to future problems. [www.naturalpaving.co.uk](http://www.naturalpaving.co.uk)

# Fossestone

**Our natural stone block paving provides an attractive long term solution for driveways due to the durability of the individual blocks, making them a natural alternative to concrete block paving.**

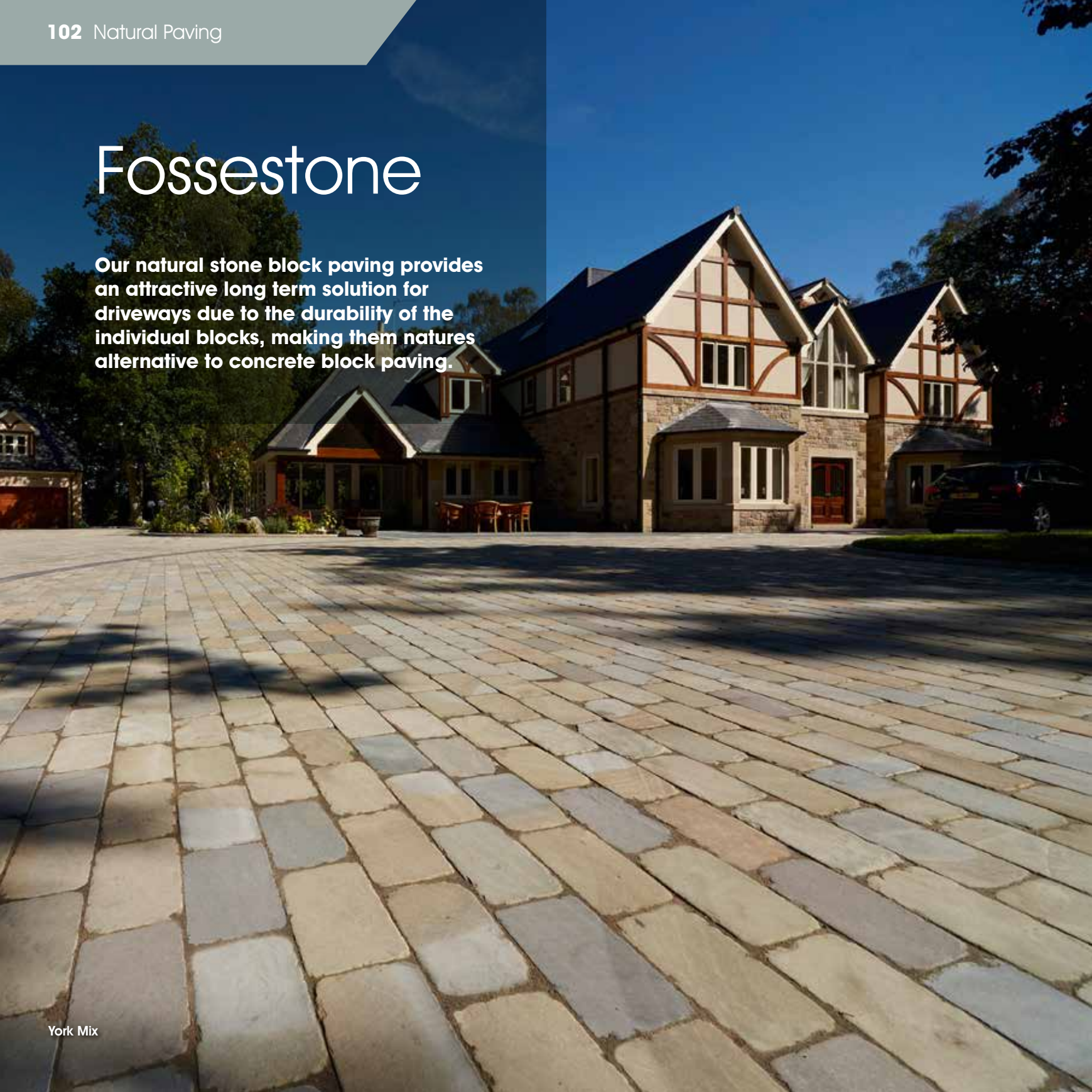

York Mix

**The Fossestone collection is a well established range of block paving, offering driveways and entrances a true sense of style. All of the blocks are 50mm in depth, however this is a nominal thickness due to the natural, riven nature of some of the surfaces. The more intense the riven texture of the surface, the greater the variance there will be in the thickness.**

With 8 inspiring colours that individually create a stunning finish, they can also be mixed and matched to incorporate contrasting borders and areas, in order to create unique designs. All products are available in mixed size project packs, with the exception of Midnight Blue and Ebony which come in single sizes.

Please note that all product sizes, weights and coverages, stated throughout this brochure are nominal.

**The Fossestone collection includes:**



pg 104  
**Orchard**

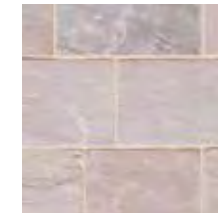

pg 106  
**Forest**

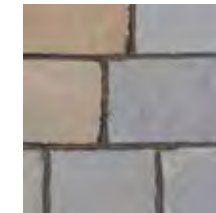

pg 108  
**York Mix**



pg 110  
**Cinder**



pg 112  
**Rustic Quartz**



pg 114  
**Midnight Blue**



pg 116  
**Birch**



pg 118  
**Ebony**



For more product images and laying patterns please visit [www.naturalpaving.co.uk](http://www.naturalpaving.co.uk) where you can also download the 'Understanding and Installing Natural Stone Guide' for information on installation and how to get the best from your natural stone products.



Edged with Midnight Blue block paving, see page 114

# Orchard



- Water Absorbency
- Flexural Strength
- Freeze-Thaw Test

Orchard is a sandstone block paver that is aged to create a riven surface and weathered look across all 6 sides. If you are looking for a matching flagstone to create a complementary patio alongside an Orchard driveway, we suggest Harvest or Maple, see pages 78 and 56 respectively for details.

Product	Thickness (mm)	Nominal weight per pack (kg)	Nominal coverage per pack (m <sup>2</sup> )	Number of pieces per pack		
				Please note that sizes are nominal		
				250mm x 150mm	200mm x 150mm	150mm x 150mm
Calibrated Project Pack	50	1200	8.5	128	80	56

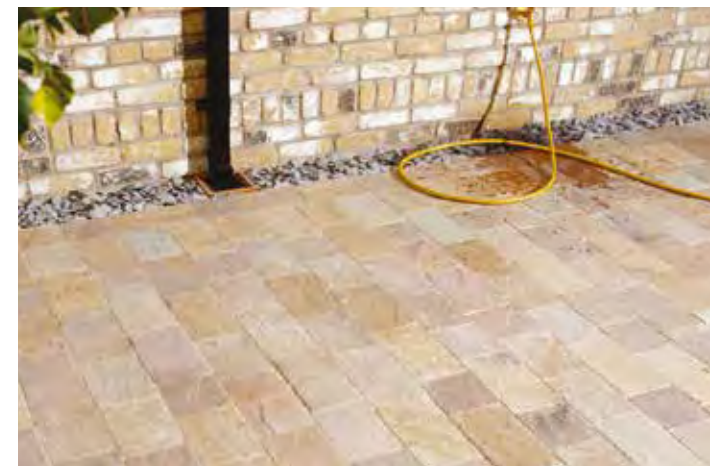



# Forest



- Water Absorbency
- Flexural Strength
- Freeze-Thaw Test

A sandstone block paver, Forest undergoes a rumbling process to create a weathered, textured finish across all 6 sides. If you are looking to create a flush finish from a Forest drive into a patio, we recommend Rydal or Lakeland flagstones, see pages 58 and 80 respectively.

Product	Thickness (mm)	Nominal weight per pack (kg)	Nominal coverage per pack (m <sup>2</sup> )	Number of pieces per pack <small>Please note that sizes are nominal</small>		
				250mm x 150mm	200mm x 150mm	150mm x 150mm
Calibrated Project Pack	50	1200	8.5	128	80	56



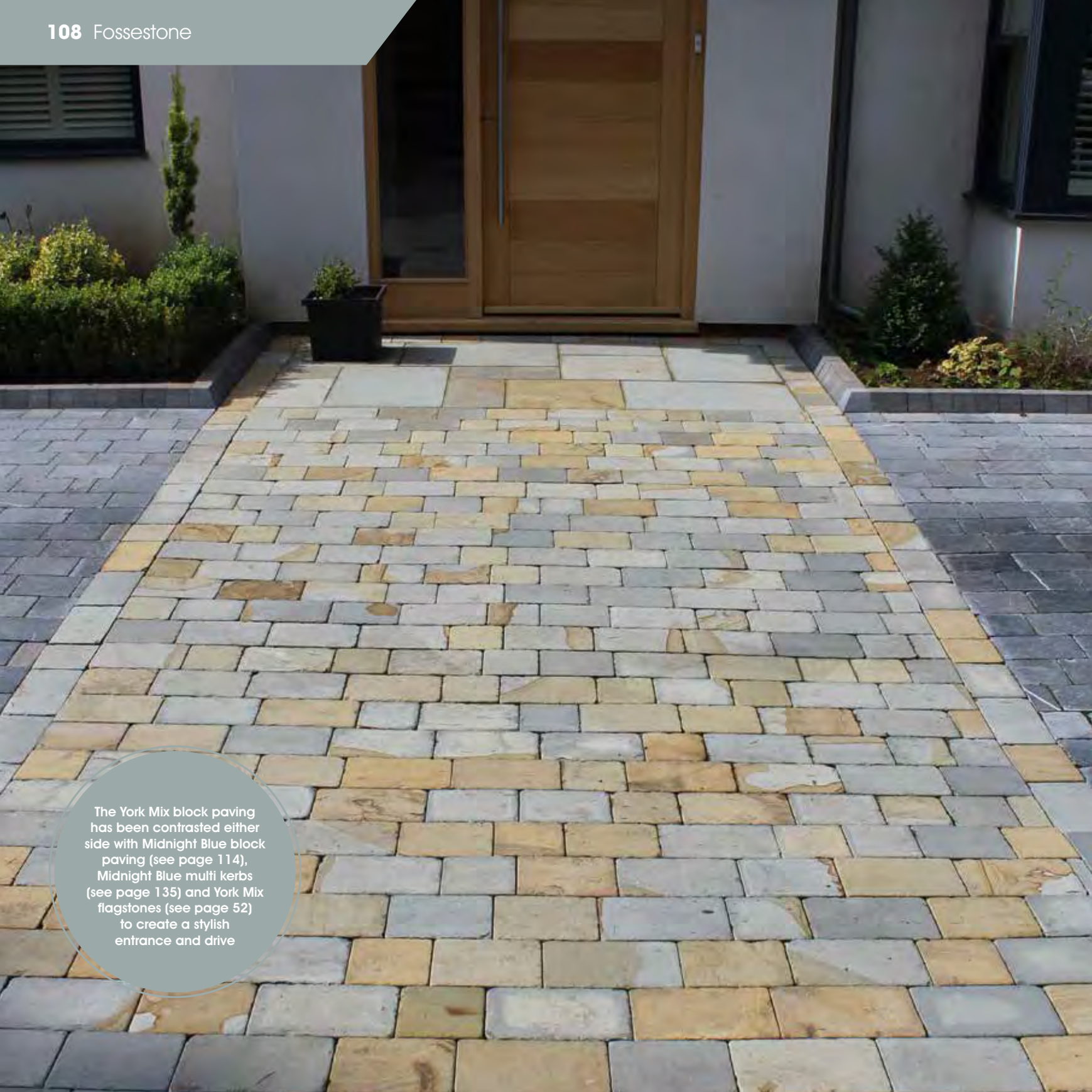

The York Mix block paving has been contrasted either side with Midnight Blue block paving (see page 114), Midnight Blue multi kerbs (see page 135) and York Mix flagstones (see page 52) to create a stylish entrance and drive

# York Mix



- Water Absorbency
- Flexural Strength
- Freeze-Thaw Test

York Mix is a beautiful multi tonal sandstone block paver, sawn cut and aged, to create a weathered finish. For a matching patio, why not use the York Mix flagstones, see page 52.

Product	Thickness (mm)	Nominal weight per pack (kg)	Nominal coverage per pack (m <sup>2</sup> )	Number of pieces per pack <small>Please note that sizes are nominal</small>		
				250mm x 150mm	200mm x 150mm	150mm x 150mm
Calibrated Project Pack	50	1200	8.5	128	80	56

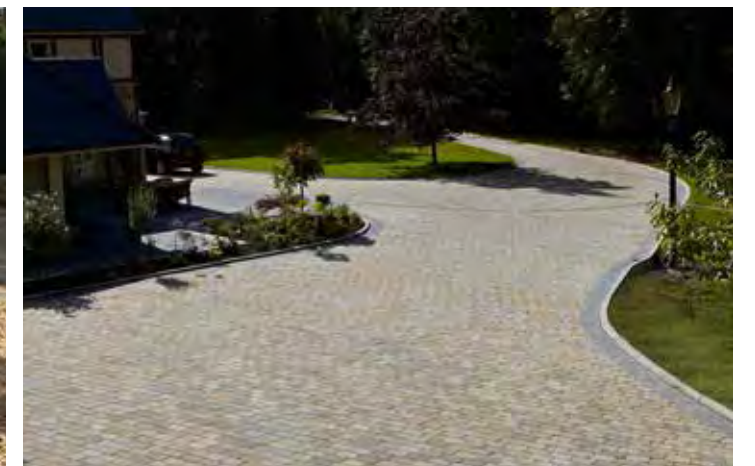

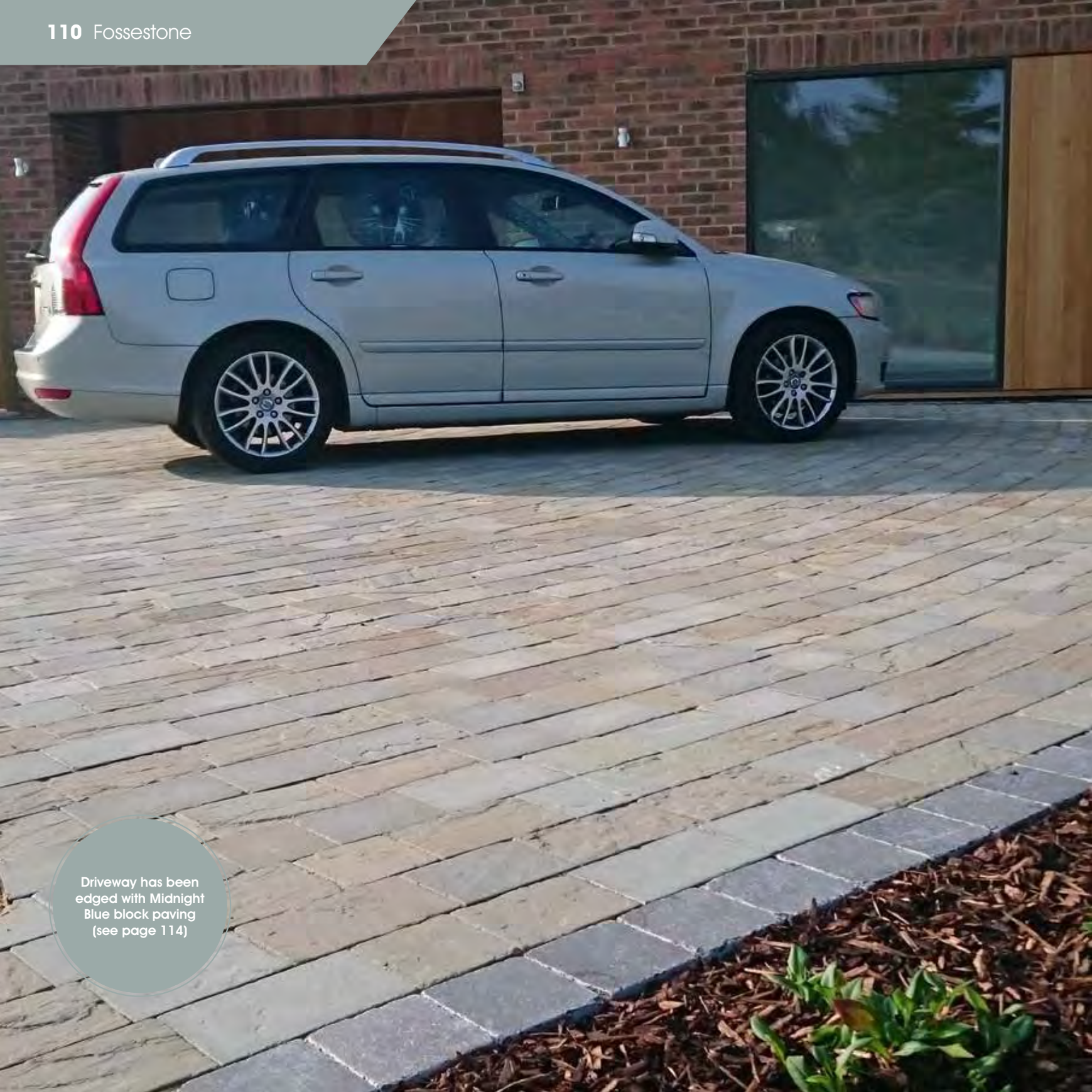

Driveway has been edged with Midnight Blue block paving (see page 114)

# Cinder



- Water Absorbency
- Flexural Strength
- Freeze-Thaw Test

Cinder is a riven block paver, made of a rumbled sandstone to create a weathered look. Cinder has a palette of varying grey tones and can contain buff and brown shades, which may come to life as it is exposed to the elements. To match a patio to a Cinder driveway, try Platinum or Pumice flagstones, each have similar colour tones but different textures to suit, see pages 54 and 48 respectively.

Product	Thickness (mm)	Nominal weight per pack (kg)	Nominal coverage per pack (m <sup>2</sup> )	Number of pieces per pack		
				Please note that sizes are nominal		
				250mm x 150mm	200mm x 150mm	150mm x 150mm
Calibrated Project Pack	50	1200	8.5	128	80	56



Driveway has been edged with Midnight Blue round top kerbs (see page 135)





Driveway has been edged with Birch block paving (see page 116)

# Rustic Quartz



The Fossestone collection's only quartzite paver, Rustic Quartz is riven and rumbled, with a coarse and aged finish. Rustic Quartz boasts rich varying shades that create impressive feature driveways and instant kerb appeal.

Product	Thickness (mm)	Nominal weight per pack (kg)	Nominal coverage per pack (m <sup>2</sup> )	Number of pieces per pack		
				Please note that sizes are nominal		
				250mm x 150mm	200mm x 150mm	150mm x 150mm
Calibrated Project Pack	50	1200	8.5	128	80	56

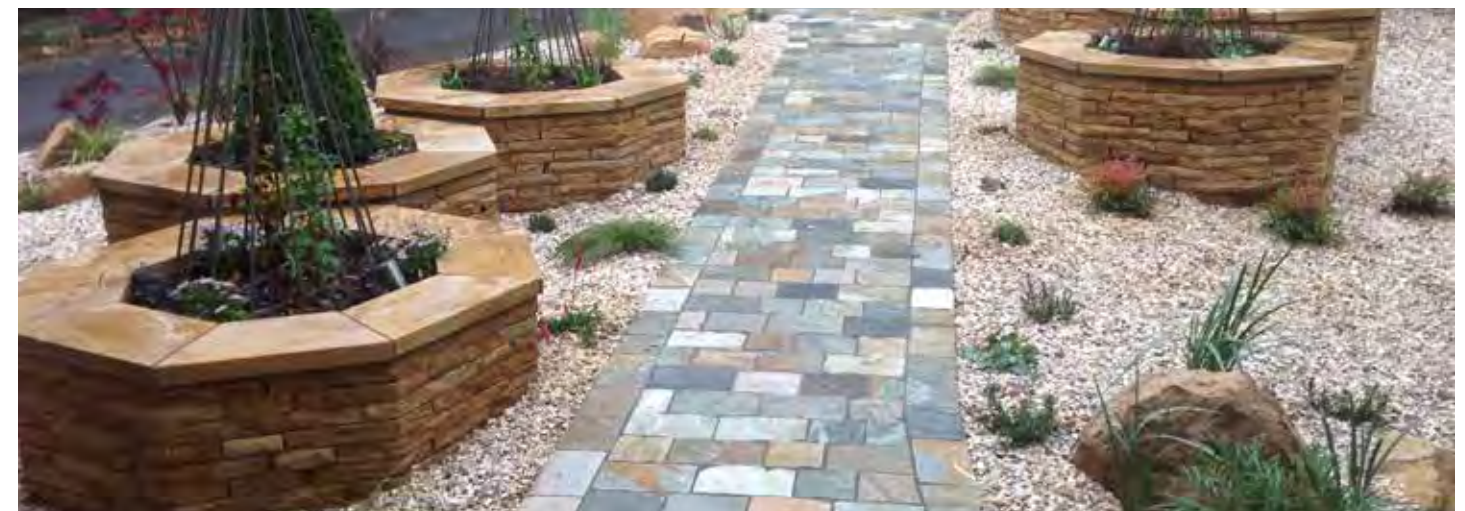



Driveway has been edged with Midnight Blue multi kerbs (see page 135)

# Midnight Blue

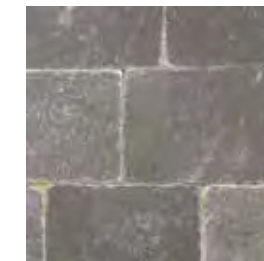

Midnight Blue is a rumbled limestone with weathered edges but a smooth honed surface.

Midnight Blue comes in 3 different single sizes. Its versatility makes Midnight Blue a highly popular choice for driveways, and is also commonly used to edge contrasting block pavers and to form stretcher courses within patio areas. Midnight Blue has matching kerbs and edgings, see page 135.

As Midnight Blue is a limestone, it may naturally lighten over time.

Product	Thickness (mm)	Nominal weight per pack (kg)	Nominal coverage per pack (m <sup>2</sup> )	Number of pieces per pack		
				Please note that sizes are nominal		
				250mm x 150mm	200mm x 150mm	150mm x 150mm
250 x 150mm Calibrated Single Size	50	1150	8.4	224	-	-
200 x 150mm Calibrated Single Size	50	1150	8.4	-	280	-
150 x 150mm Calibrated Single Size	50	1200	8.8	-	-	392

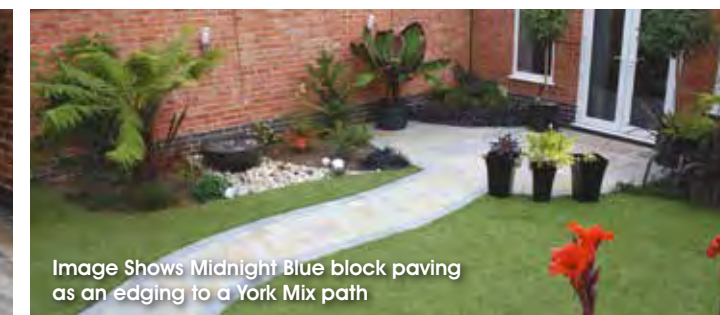
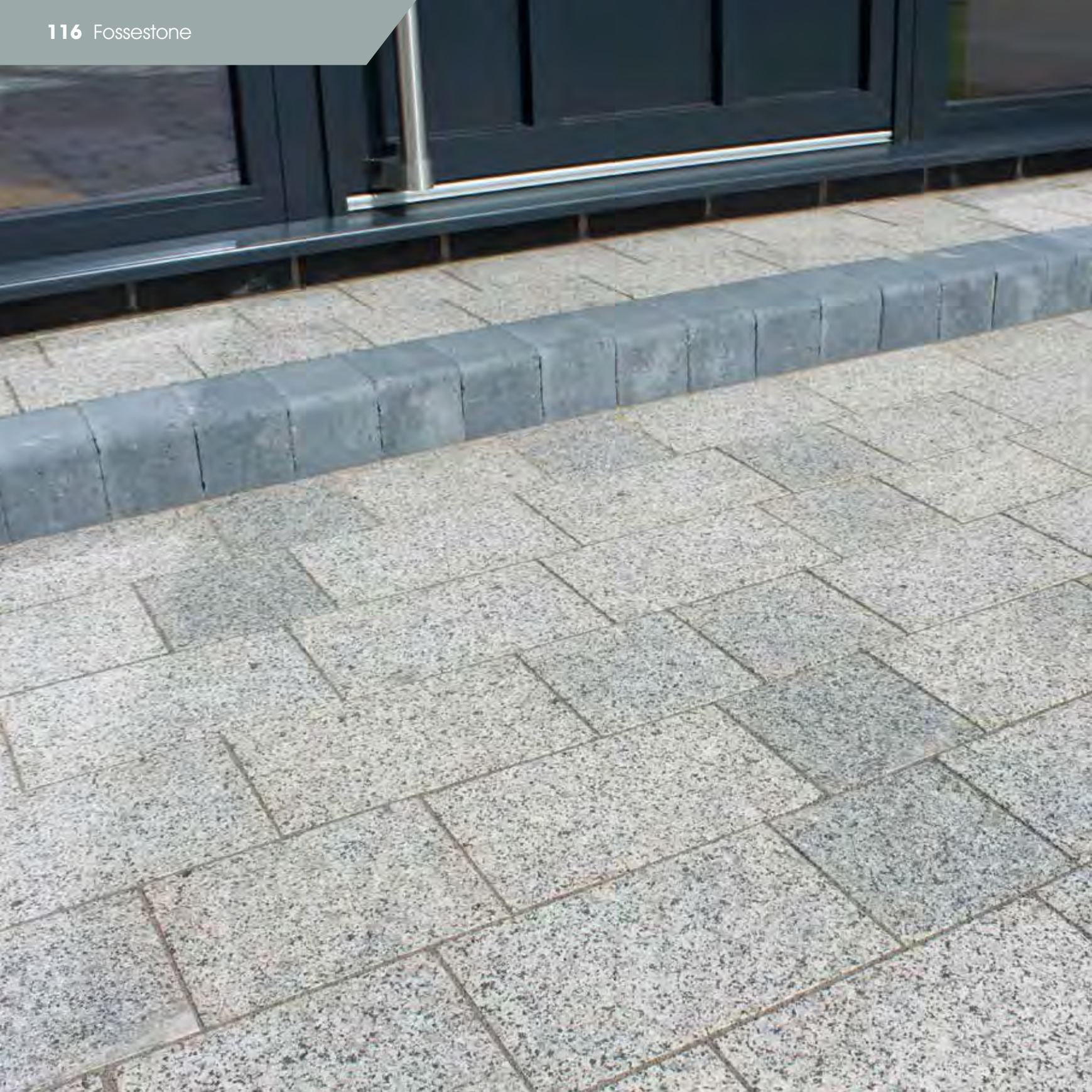

Image Shows Midnight Blue block paving as an edging to a York Mix path



# Birch



A flamed silver granite, Birch has a rich surface texture with beveled edges. Birch is also available in flagstones, see page 36.

Product	Thickness (mm)	Nominal weight per pack (kg)	Nominal coverage per pack (m <sup>2</sup> )	Number of pieces per pack		
				Please note that sizes are nominal		
				250mm x 150mm	200mm x 150mm	150mm x 150mm
Calibrated Project Pack	50	1200	8.5	128	80	56

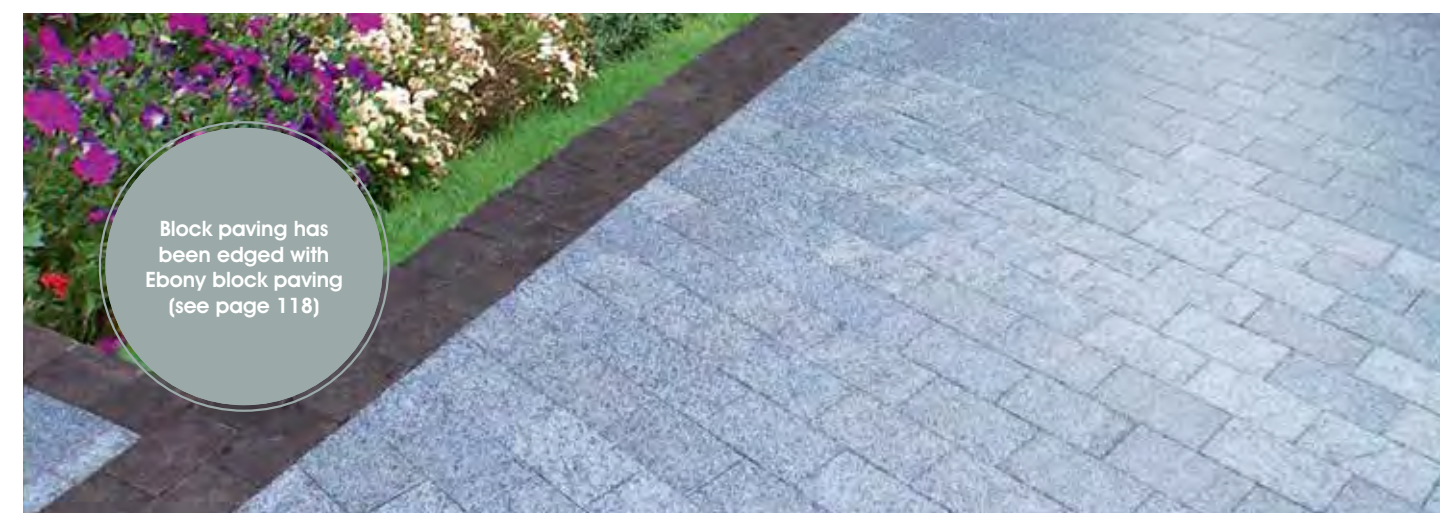

Block paving has been edged with Ebony block paving (see page 118)



# Ebony

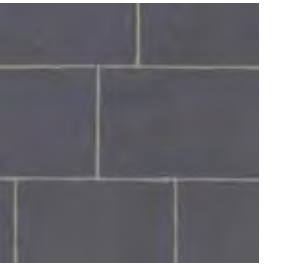

Ebony, the latest edition to the Fossestone collection is a dark rumbled limestone product. With 4 sawn edges and a naturally riven surface, this black block paver offers a traditional feel in a contemporary colour.

As Ebony is a limestone, it may naturally lighten over time.

Please note that on the images shown, the installers have cut down the 250 x 150mm single sizes to produce smaller blocks for a random pattern effect.

Product	Thickness (mm)	Nominal weight per pack (kg)	Nominal coverage per pack (m <sup>2</sup> )	Number of pieces per pack
250 x 150mm Calibrated Single Size	50	1150	8.4	224

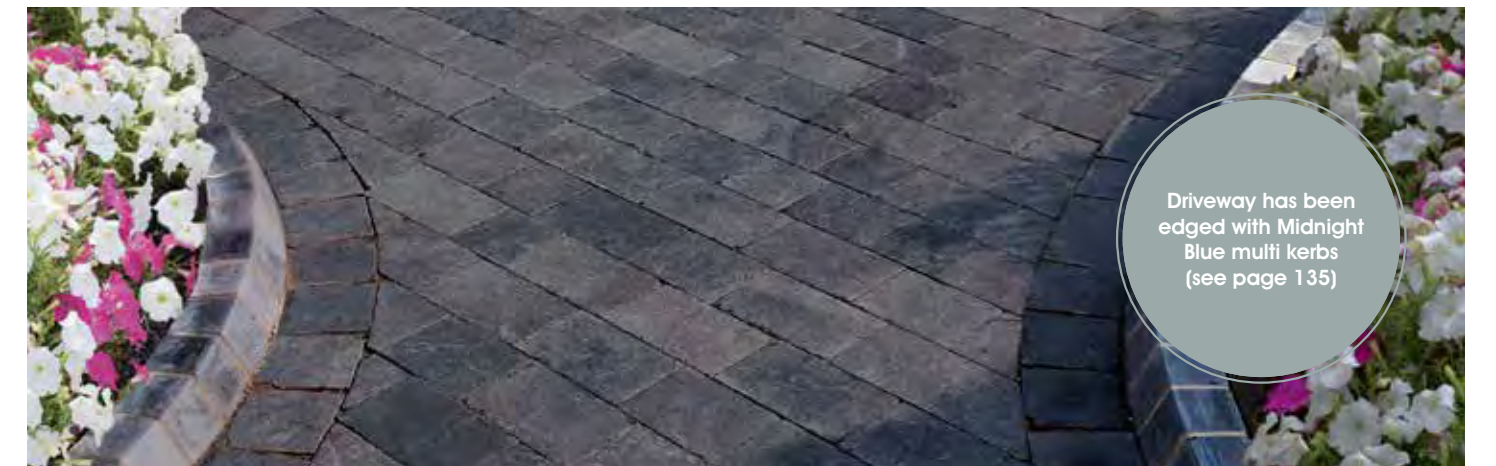

Driveway has been edged with Midnight Blue multi kerbs (see page 135)



Orchard



Birch



Midnight Blue



Rustic Quartz



York Mix

# Installation

If you are looking for help with the design and/or installation of your paving, you can find a list of Landscaping Professionals on our website [www.naturalpaving.co.uk/landscaping-professionals](http://www.naturalpaving.co.uk/landscaping-professionals)

For information regarding installation you can refer to our 'Understanding and Installing Natural Stone Paving' guide and there are also many independent sources of further detailed advice available, for example The Paving Expert [www.pavingexpert.com](http://www.pavingexpert.com)



Download our 'Understanding and Installing Natural Stone Paving' guide for further details on how to carefully install your paving for best results, as incorrect installation methods can lead to future problems. [www.naturalpaving.co.uk](http://www.naturalpaving.co.uk)



# Cobblestone

The Cobblestone collection offers a range of 12 versatile, charming and stylish products to accessorise any part of your garden.

We have 2 silver granite setts, 4 weathered sandstone cobbles, 3 smooth sawn and honed sandstone cobbles and 3 European cobbles, offering a variety in colour and surface finish.

Please note that all product sizes, weights and coverages, stated throughout this brochure are nominal.

- Silver Setts pg 123
- Weathered Cobbles pg 124
- Smooth Face Cobbles pg 126
- European Cobbles pg 128

Ebony cobbles (see page 125) edged with Meadow cobbles (see page 125) and jointed with black Pavetuf Jointing Compound (see page 155)

# Silver Setts



100 x 100 x 100mm    100 x 100 x 50-70mm

A traditional looking stone, our granite setts are a fantastic product for creating a rustic feel and will give any courtyard space an impressive finish. With a versatile edge, the granite setts can also be used with contemporary products to create an on trend garden or bespoke feature.

Product	Thickness (mm)	Nominal weight per pack (kg)	Nominal coverage per pack (m <sup>2</sup> )	Number of pieces per pack
100 x 100mm Single Size	100	1100	5	400
100 x 100mm Single Size	50 - 70	1200	10	800



For more product images and laying patterns please visit [www.naturalpaving.co.uk](http://www.naturalpaving.co.uk) where you can also download the 'Understanding and Installing Natural Stone Guide' for information on installation and how to get the best from your natural stone products.

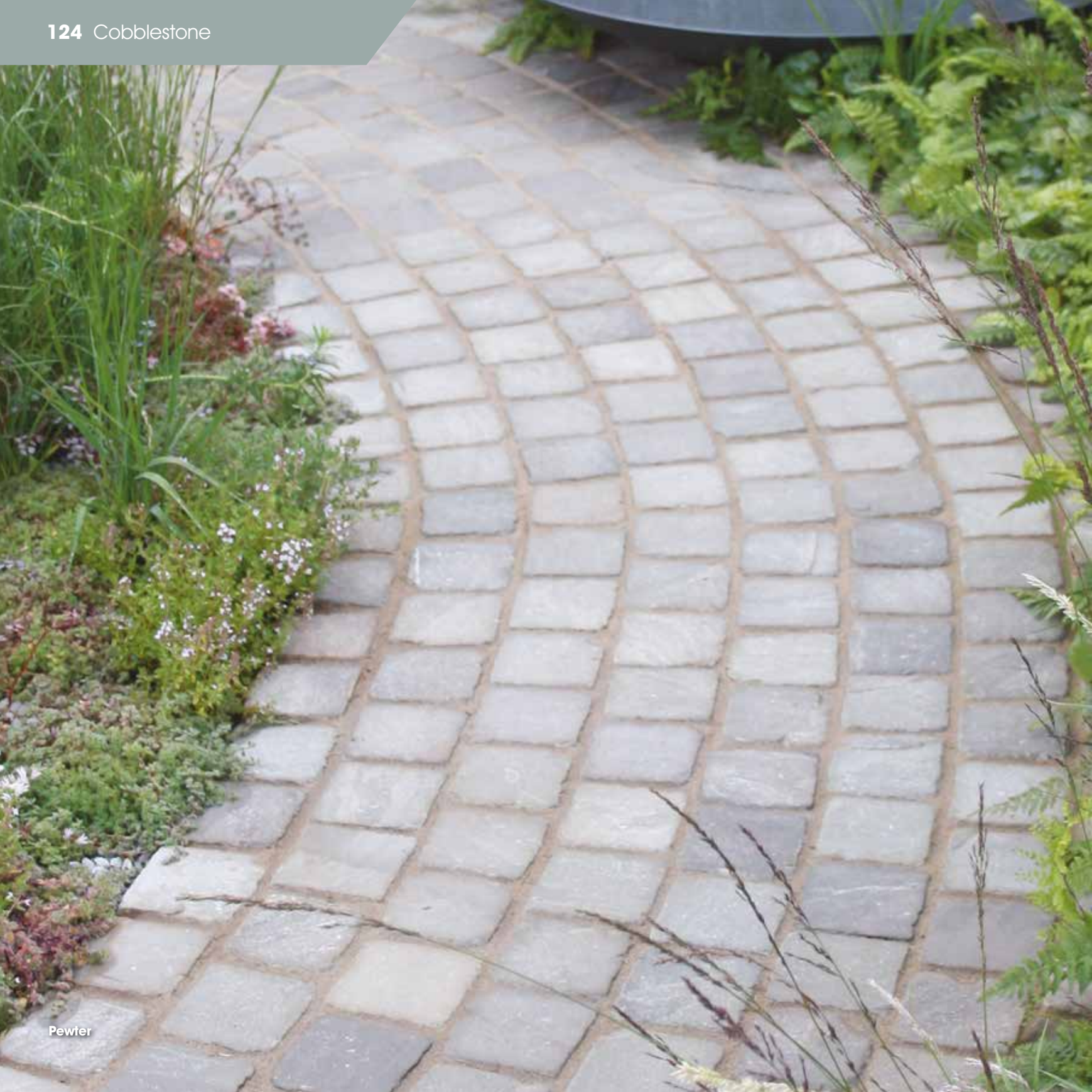

# Weathered Cobbles



Calico

Ebony



Meadow

Pewter

Our range of weathered cobbles can be used in a variety of applications including patios, paths, edging features, courtyards and driveways. Please note that if you wish the cobbles to take vehicular traffic, they must be laid on a full bed of mortar and we recommend a strong jointing mortar to be used for jointing the cobbles, like the Pavetuf Jointing Mortar (see page 155).

Our weathered cobbles collection includes 4 traditional options; Calico (sandstone), Ebony (limestone), Meadow (sandstone) and Pewter (sandstone), which are naturally split with an antique finish, ideal for cottage style courtyards and traditional settings.



Calico

Ebony

Meadow

Pewter

As Ebony is a limestone, it may naturally lighten over time.

Product	Thickness (mm)	Nominal weight per pack (kg)	Nominal coverage per pack (m <sup>2</sup> )	Number of pieces per pack <small>Please note that sizes are nominal</small>				
				200mm x 150mm	200mm x 100mm	150mm x 150mm	100mm x 150mm	100mm x 100mm
Project Pack	25 - 50	1100	15	195	-	195	195	-
100 x 100mm Single Size	25 - 50	500	6	-	-	-	-	500
200 x 100mm Single Size*	25 - 50	500	6	-	250	-	-	-



Meadow edged with Ebony

\*Only available in Ebony

Pewter



Cobbles have been bordered with Maple linear flagstones (see page 57) to create a contemporary feel ideal for a modern city terrace or small courtyard

Grasmere Cobbles

# Smooth Face Cobbles

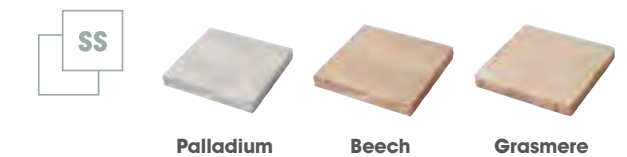

Our range of sawn sandstone cobbles can be used in a variety of applications including patios, paths, edging features, courtyards and driveways. Please note that if you wish the cobbles to take vehicular traffic, they must be laid on a full bed of mortar and we recommend a strong jointing mortar to be used for jointing the cobbles, like the Pavetuf Jointing Mortar (see page 155).

Palladium, Beech and Grasmere, all have natural edges but with a modern smooth, sawn surface, for projects that demand a more contemporary look.

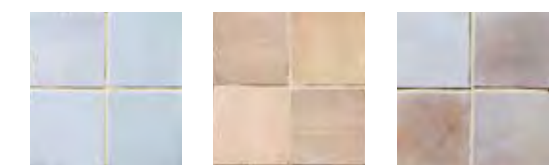

Palladium Beech Grasmere

Product	Thickness (mm)	Nominal weight per pack (kg)	Nominal coverage per pack (m <sup>2</sup> )	Number of pieces per pack
100 x 100mm Calibrated Single Size	20	500	6	500



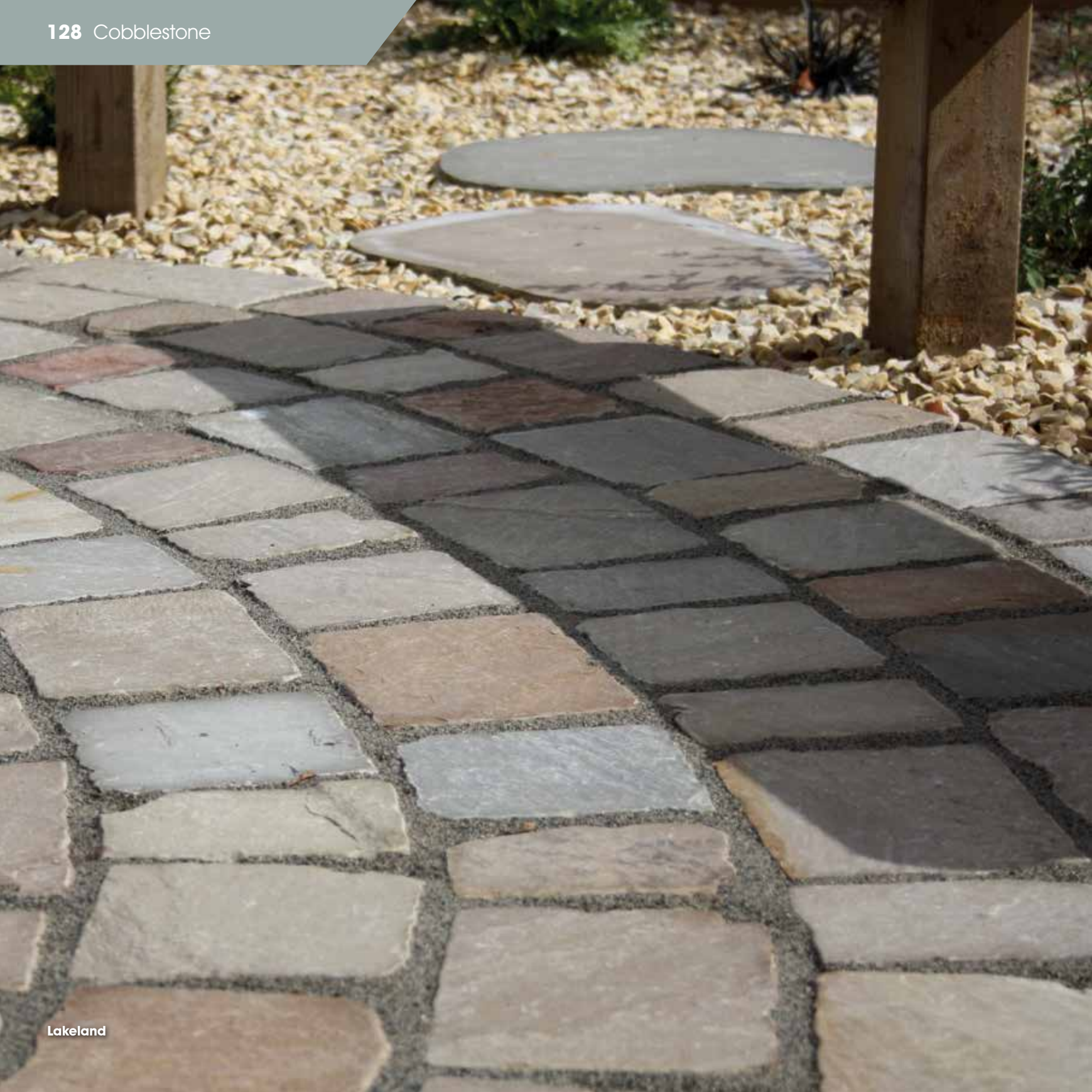

# European Cobbles



Lakeland



Promenade



Chocolate

The European cobbles are a cosmopolitan range that have been designed to offer an alternative choice of cobble sizing, reflecting the sizes often found in European streets and gardens.

A chic range, the European cobbles have a naturally riven surface and 'un certain je ne sais quoi'.

Please note the image shows a combination of 200 x 140mm and 140 x 140mm singles size cobbles.



Lakeland



Promenade



Chocolate

Product	Thickness (mm)	Nominal weight per pack (kg)	Nominal coverage per pack (m <sup>2</sup> )	Number of pieces per pack	Colour		
					Lakeland	Promenade	Chocolate
200 x 140mm Single Size	60 - 80	1000	6.80	204	✓	✓	
200 x 140mm Single Size	30 - 50	1000	11.90	357	✓	✓	
140 x 140mm Single Size	60 - 80	1000	6.95	292	✓	✓	
140 x 140mm Single Size	30 - 50	1000	12.14	510	✓	✓	
100 x 100mm Single Size	60 - 80	1000	6.88	571	✓		
100 x 100mm Single Size	70 - 90	1000	6.50	500			✓

# Walling

As part of the Natural Paving range, we offer Cottagestone Walling.

Cottagestone walling is available in Golden Fossil, Lakeland and Carbon Black.



Walling has been finished on top with Grasmere cobbles (see page 127)

Lakeland walling, showing pitch face

# Cottagestone



Golden Fossil

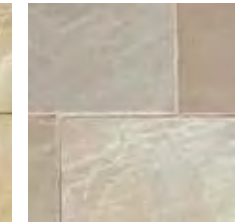

Lakeland



Carbon Black

Cottagestone walling is available in Golden Fossil, Lakeland and Carbon Black. Each walling product has a choice of laying options, the pitched face creates an aged effect whilst the riven face conveys a traditional look.

To complement the walling, matching copings are available, see page 133 for details. Please note that time should be taken to course the blocks prior to installation. As Carbon Black is a limestone, it may naturally lighten over time.

Product	Nominal course height (mm)	Nominal course width (mm)	Nominal weight per pack (kg)	Nominal coverage per pack (m <sup>2</sup> )	Number of pieces per pack <small>Please note that sizes are nominal</small>		
					365mm x 100mm	300mm x 100mm	220mm x 100mm
Walling Stone Mixed Pack	50 - 75*	100	1100	5*	75	75	75

\*This is based on the walling being laid to show the pitched face. If the walling is laid to reveal the riven face, the course height will be 100mm and each pack will cover a nominal area of 7.5m<sup>2</sup>.



**Golden Fossil walling riven face**  
*Riven Face: derived from a natural split on the stone*



**Lakeland walling pitched face**  
*Pitch Face: gives a hand chiseled, unique look*



**Carbon Black walling pitched face**



For more product images and laying patterns please visit [www.naturalpaving.co.uk](http://www.naturalpaving.co.uk) where you can also download the 'Understanding and Installing Natural Stone Guide' for information on installation and how to get the best from your natural stone products.

# Stone Accessories

**Accessories provide an additional layer and depth to existing outdoor features, with contrasting colours and finishes that make your designs naturally unique.**

Please note that all product sizes, weights and coverages, stated throughout this brochure are nominal.

**Copings**  
**Stepping Stones**  
**Kerbs & Edgings**

**pg 132**  
**pg 134**  
**pg 135**

For more product images and laying patterns please visit [www.naturalpaving.co.uk](http://www.naturalpaving.co.uk) where you can also download the 'Understanding and Installing Natural Stone Guide' for information on installation and how to get the best from your natural stone products.



50mm bullnose coping, Pumice

# Copings

## For Step Kits, Pools and Walling



Our versatile coping products have been designed for use as steps, pool copings and wall copings, enabling a consistent finish to be created within any designed landscape project. In a variety of colours, the range of copings will complement a wide range of our flagstones, walling and block paving. To suit different design preferences some copings are available with a bullnose edge and others with a natural edge. All are made from sandstone, except Carbon Black, which is a limestone and may naturally lighten over time.



**Bullnose copings with a lightly textured surface**

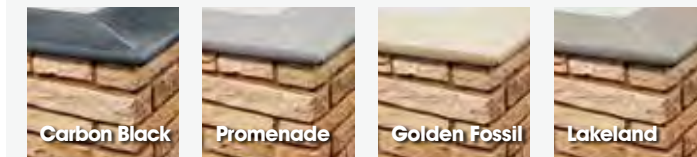

**Bullnose copings with a naturally riven textured surface**



**Natural chiseled copings with a naturally riven finish to top and front edge**

### Bullnose copings



### Natural chiseled wall copings



Product	Thickness (mm)	Nominal weight per pack	Nominal coverage linear metres per pack	Number of pieces per pack
600 x 300mm bullnose coping	50	250	7.2	12

Please note that these size copings are designed for walling only.

Product	Thickness (mm)	Nominal weight per pack	Nominal coverage linear metres per pack	Number of pieces per pack
600 x 150mm natural chiseled	40	750	60	100



Lakeland Stepping Stones

# Stepping Stones

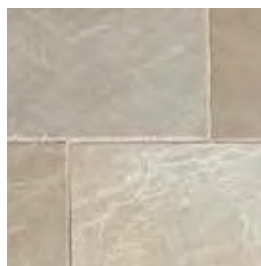

Our Lakeland sandstone stepping stones create unique connecting features to and from areas of your garden. Use Lakeland stepping stones as a feature alongside Lakeland flagstones, this will make a popular choice of paving unique and personalised, see page 80 for details.

Product	Size (mm)	Thickness (mm)	Nominal weight per pack (kg)	Number of pieces per pack
Calibrated, Random Shaped Stepping Stones	500 x 350 (approx)	24	900	72

# Kerbs and Edgings



To really give your driveway and garden a natural edge over all others, choose from one of our Midnight Blue limestone, Promenade and Lakeland sandstone finishing products. As Midnight Blue is a limestone, it may naturally lighten over time.

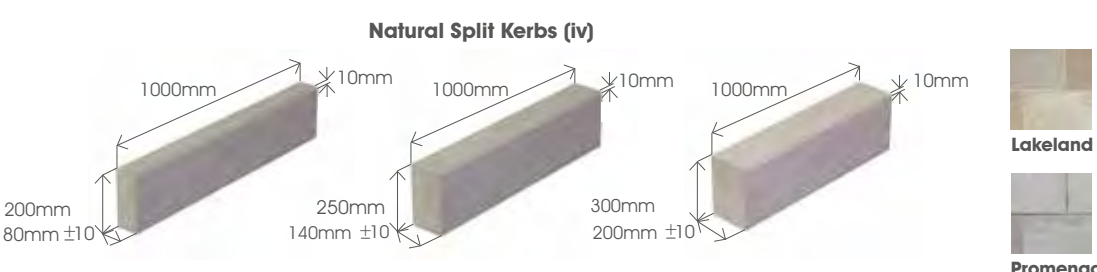
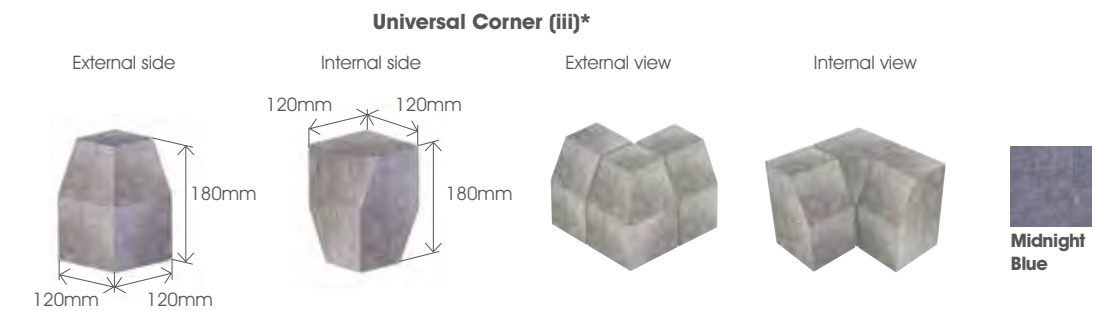
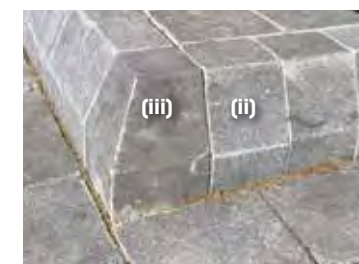

Product Single Sizes	Size (mm)	Nominal weight per pack (kg)	Nominal coverage linear metres per pack	Number of pieces per pack	Colours
Round Top (i)	600 x 180 x 50	700	24	40	Midnight Blue
Multi Kerb (ii)	180 x 120 x 100	750	12.5	125	Midnight Blue
Universal Kerb (sold individually) (iii)*	180 x 120 x 120	7	0.12	1	Midnight Blue
Natural Split Kerb (iv)	1000 x 200 x 70 - 90	1000	30	30	Promenade & Lakeland
Natural Split Kerb (iv)	1000 x 250 x 130 - 150	1000	13	13	Promenade & Lakeland
Natural Split Kerb (iv)	1000 x 300 x 190 - 210	1000	9	9	Promenade & Lakeland

# Choose bespoke

If you are looking for landscaping products for commercial and/or highly tailored design projects, we offer a bespoke supply service. Our Technical Team are there to advise on specification and technical issues relating to your bespoke projects and specialise in:

- Take off's from drawings and Bill of Quantities for commercial and special projects
- Ordering specific thicknesses and sizes of stone paving and ancillaries
- Utilising your designs, CAD drawings, sketches and architect drawings and turning them into functional working drawings

From our own quarries and factories, we can produce an array of bespoke natural stone solutions and have contacts worldwide to import many variations of stone and landscaping materials.

## Recent Case Studies:



**Black Bull Inn, Moulton**  
(Bespoke cut paving, copings and steps)



**Centre for Digital Innovation, Hull**  
(Bespoke cut sandstone paving, copings and steps)



**District Police Headquarters, Leeds**  
(Bespoke cut paving, tactile paving and steps with granite inserts)



**Miller Homes, Birkacre Park, Eaves Green, Chorley**  
(Bespoke cut paving and kerbs)

## Our range of commercial and high specification products include:

- Granite, Limestone & Sandstone Paving
- Blyko Concrete Paving
- Porphyry Paving
- Setts, Cubes & Binders
- Sustainable Paving Solutions
- Tactile Paving
- Kerbs, Steps & Edgings

For a copy of the Commercial Brochure or if you have a specific project that requires bespoke cut stone and design support, please contact our Technical Team on **0330 333 8030**.

Download a copy of our 'High Specification and Commercial Products' brochure from [www.naturalpaving.co.uk](http://www.naturalpaving.co.uk)

# Choose ethically

After choosing the style, colour and finish of your stone another very important consideration should be the sourcing of this stone. The best way to ensure that your choice of stone has been ethically sourced, is to check that the stone supplier is a member of the Ethical Trading Initiative (ETI) and can prove good ethical practices in manufacturing and can demonstrate appropriate activity within the human rights arena. Natural Paving has been a full member of the ETI for several years and takes an active role in their specialist Stone Group.

We import from a number of countries to offer the best in choice but unlike our UK competitors we also work in partnership with our sole supplier, Stone Exporters India Pvt Limited to manage a number of quarries and factory facilities in India.

As a manufacturer, we invest in our supply chain and the people that work in it. Fully aware of inhumane practices (including child labour), that exist in parts of the world, Natural Paving has made a firm commitment to demonstrate to our industry, just how natural stone mining should be conducted successfully and ethically.

Our recent work with the SCMCH School and hostel, local to the new factory has included the installation of a new clean

drinking water system, the installation of a new 10 station computer classroom and financial donations to this very worthy cause. The local media have taken an interest in our work, which we hope will enhance our acceptance into this village and enable us to give something back to the community. Our long term commitment to this project is to make life much better for the Children at SCMCH and of the villages of Madhya Pradesh.

Stone Exporters India Pvt Limited has partnered with New Delhi based NGO, Bachpan Bachao Andolan (BBA) since 2015 to improve the lives of Indian children near the quarries and is funding 10 new Child Friendly Villages as part of its 'Bal Mitra Gram' programme. BBA has worked tirelessly throughout decades to eradicate child exploitation and promote child rights.

These child friendly villages, set up by the BBA, ensure every child up to the age of 14 gets a quality education and there is a community ban on all child labour and child marriage. Stone Exporters have also opened a new state-of-the-art factory, which will provide further job opportunities to local people. The 'Bal Mitra Gram' programme was recently launched at the factory and attended by over 2000 people.



**The Schedule Cast Metric Children's Hostel (SCMCH)**



## Kailash Satyarthi

The image above shows Nobel Peace prize winner, Kailash Satyarthi, the founder of the BBA.



**Kailash says** "I am extremely pleased to be working with the Natural Paving brand and their sister company Stone Exporters in India, between us we can achieve a lot of great things in the stone industry, I have been really impressed with what the group have been doing already and I look forward to making a difference with them".

# Stone: Our end to end solution

*With control over quality, supply and product range, we deliver a full end to end service.*



**Our natural stone landscaping products, destined for beautiful homes and gardens, follow a careful journey that is controlled and overseen by the Talasey Group. To ensure you receive the very highest standards in quality and service, our unique service offering means that we handle the stone from quarry to garden.**

## We quarry

We source products globally but quarry the majority from our sole supplier, who we partner with in India, so we can guarantee that all of our products are ethically sourced.

## We manufacture

Once the stone is out of the ground, we have multiple factory sites with state of the art machinery where it is processed, cut and shaped. This enables us to offer a vast range of products in terms of finishes and sizes.

## We import and distribute

We manage a fleet of vehicles in India, partner a shipping company, stock our full range in the UK, operate 4 UK distribution centres (Tilbury, Doncaster, Grangemouth and Southampton) and have a dedicated haulage agent, so we can guarantee the timely and consistent supply of products, as you need them.

## We supply

We have a reputable and large network of stockists across the UK, who we partner with, ensuring that together, we provide you with the right product and respond efficiently and effectively to your requirements.

## We help design and install

We can suggest local and independent designers, contractors and installers, through our landscaping professionals membership scheme, to help ensure that your natural stone products are installed perfectly into beautifully designed outdoor living spaces.





# BAKSTEEN®

CLAY BRICKS AND PAVERS



# Baksteen

Available in a range of colours and surface finishes, Baksteen clay pavers are tumbled to reveal a weathered and antiqued appearance.

Please note that product sizes, weights and coverage stated are nominal.

**Continental  
Dutch Square**

**pg 142  
pg 144**

Please visit [www.baksteen.co.uk](http://www.baksteen.co.uk) for further product information

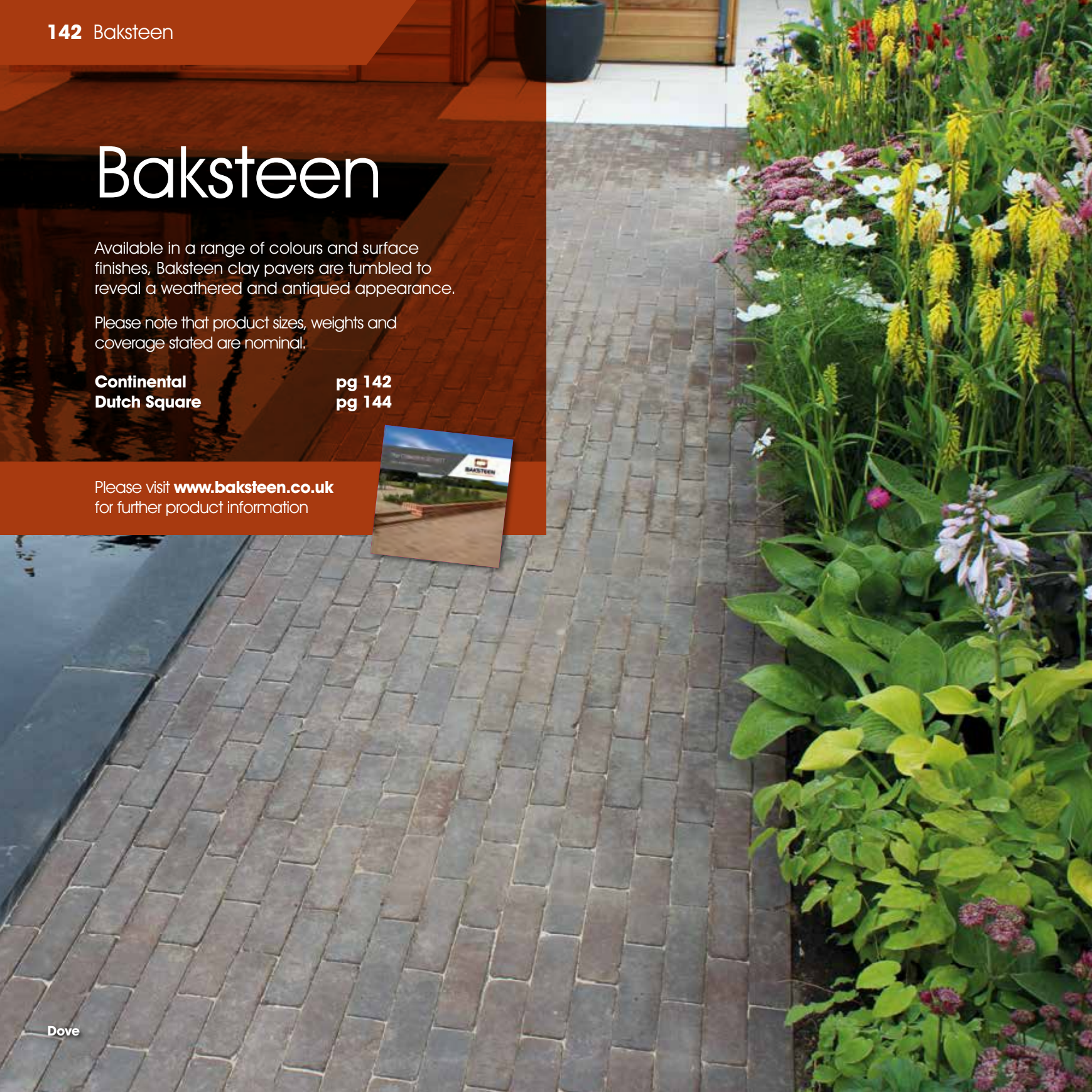

Dove

# Continental



The Continental range offers a Dutch clay paver in a versatile rectangular format which can be used to create a brick effect, herringbone and many more styles. When laid on edge, on a suitably designed bedding and sub-base, these pavers will withstand heavy vehicular traffic. Alternatively, they can be laid on bed, making them suitable for pathways, garden borders, light vehicular traffic and pedestrian use.

Choose from one of our 9 colours or select more to create a unique blend.



**Mulberry Chestnut Crimson Honeycomb Smoke**



**Ash Silver Birch Dove Mallow**

Product - Single Size Packs	Thickness (mm)	Average nominal weight per pack (kg)	Nominal coverage per pack (m <sup>2</sup> )	Number of pieces per pack
200 x 50mm (laid on edge)	65	1250 - 1466	9.6	960
200 x 65mm (laid on bed)	50	1250 - 1466	12.63	960

Baksteen clay pavers should be laid in accordance with BS 7533:Part3 :2005 – Code of Practice for Laying Precast Concrete Paving Blocks and Clay Pavers for Flexible Pavements. For further information and laying guides, please visit [www.baksteen.co.uk](http://www.baksteen.co.uk)



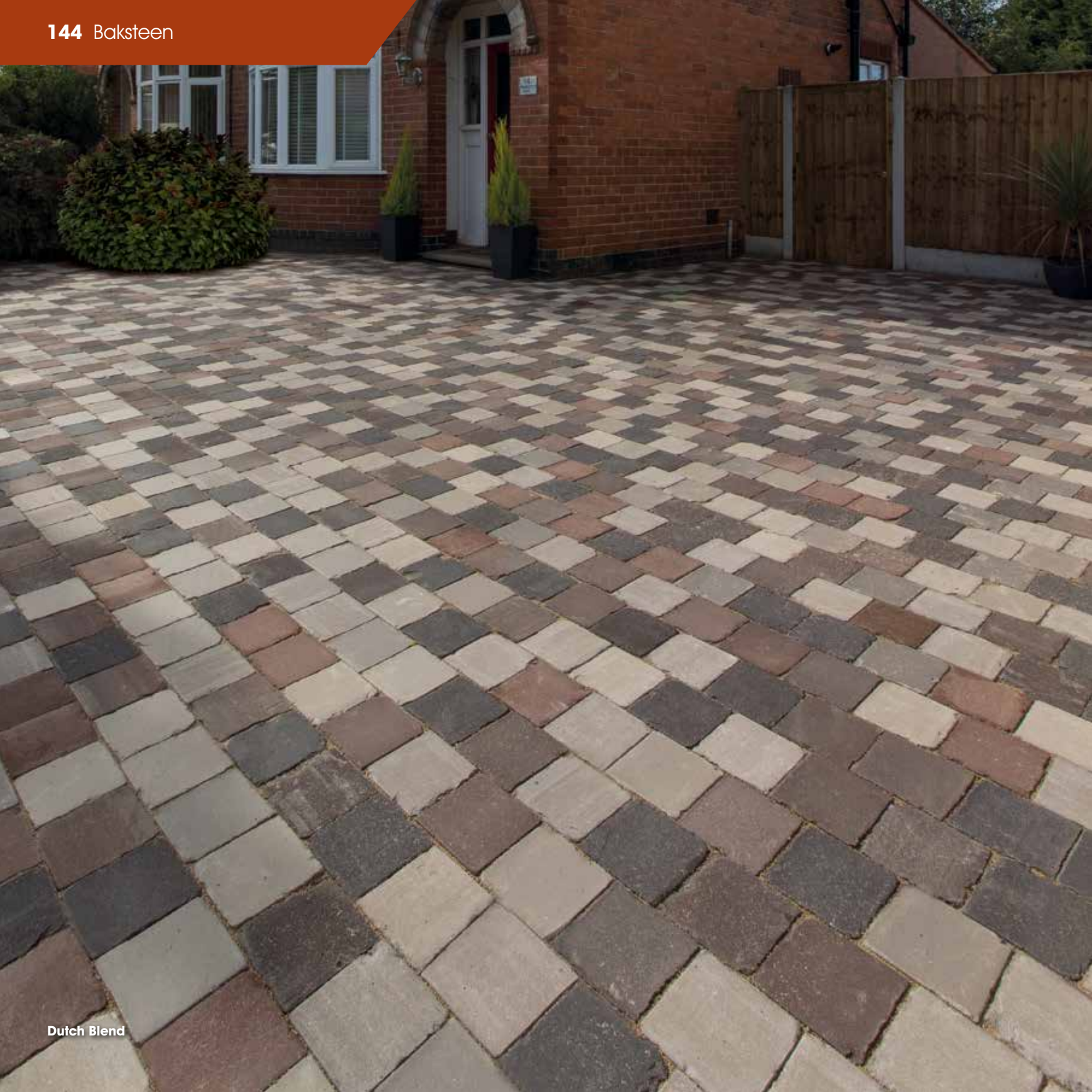

# Dutch Square



The Dutch Square range is new for 2018 and presents 4 individual colours (2 of which can be found in the Continental range: Smoke and Mallow), plus our unique 'Dutch Blend' which incorporates each of the 4 single colours (Pecan, Smoke, Mallow and Miller).

Due to the square format of this range, the Dutch Square pavers are ideal for creating edgings and channels within paved areas. Mix and match the Dutch Square and Continental range size formats for bespoke designs.

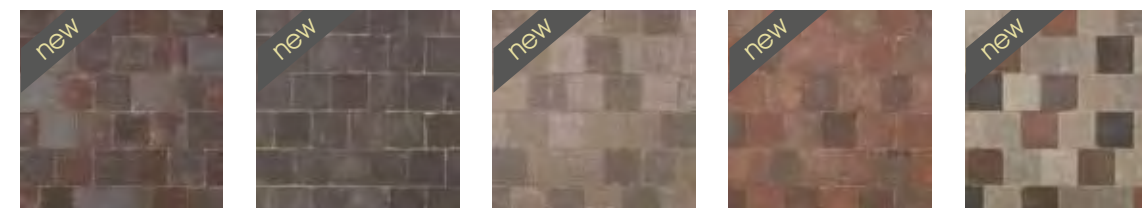

**Pecan**      **Smoke**      **Mallow**      **Miller**      **Dutch Blend**

Product	Thickness (mm)	Nominal weight per pack (kg)	Nominal coverage per pack (m <sup>2</sup> )	Number of pieces per pack
150mm x 150mm Single Size	65	1482	9.3	420

Baksteen clay pavers should be laid in accordance with BS 7533:Part3 :2005 – Code of Practice for Laying Precast Concrete Paving Blocks and Clay Pavers for Flexible Pavements. For further information and laying guides, please visit [www.baksteen.co.uk](http://www.baksteen.co.uk)

Dutch Blend



**Luxigraze**<sup>®</sup>  
ARTIFICIAL GRASS



# Luxigraze

## Each Luxigraze artificial grass product:

- ✓ Is supplied in 2m and 4m widths, up to 25m lengths
- ✓ Can be cut to size (to the nearest metre) to suit the specific needs of individual projects
- ✓ Has a multi tone green pile, with a brown thatch, providing a realistic appearance
- ✓ Is composed of polyethylene (PE) monofilament with a polypropylene (PP) texturised root zone, ensuring a soft and luxurious feel (Please note that the 30 Luxury has a slightly different construction, formed from field green and apple green polyethylene (PE) monofilament with a tan and chocolate brown polyethylene texturised root zone.)
- ✓ Has a high quality latex backing, pre-punched for drainage

For more detailed specifications, installation guide and information on our Luxigraze product range, please visit our website on [www.luxigraze.co.uk](http://www.luxigraze.co.uk)



# Luxigraze Artificial Grass

Luxigraze is a high quality range of artificial grass products designed for beautiful, all year round, low maintenance gardens. Luxigraze is available in a variety of specifications, each providing a durable, child and pet friendly lawn, creating a safe outdoor environment for all the family.



## 20 Premium - 20mm

With a shorter 20mm pile height, Luxigraze 20 Premium gives the appearance of a freshly cut lawn all year round. Ideal for roof terraces, patios, balconies and lawns.



## 30 Premium - 30mm

For a natural looking lawn, Luxigraze 30 Premium is the perfect choice. Utilising soft and hardwearing fibres, it is a realistic alternative to natural grass that looks and feels like the real thing! A popular choice for lawns, landscapes and schools.



## 30 Luxury - 30mm

Luxigraze 30 Luxury is a luscious, soft artificial grass, designed to provide a beautiful, realistic looking lawn. The natural texture is created by the soft, yet hard wearing yarn, providing a luxurious feel, which is particularly suitable for children to play on. A perfect choice for lawns, schools and nurseries.



## 32 Luxury - 32mm

Luxigraze 32 Luxury is designed to look as stunning as natural turf. This high quality artificial grass is flexible and durable, creating a soft and comfortable feel underfoot. Transform your lawn, garden or play area with this versatile artificial grass.



## 27 Super Luxury - 27mm

A top of the range, exceptionally lush artificial grass, Luxigraze 27 Super Luxury is a superior quality for garden lovers. Combining a dense deep pile, with natural looking multi green fibres, it is super soft yet super resilient, creating a luxurious lawn. Perfect for landscaping, gardens, schools and nurseries.

Luxigraze is manufactured in Europe to the highest standards, providing a 10 year UV guarantee.



The 27 Super Luxury has been teamed with Natural Paving York Mix flagstones and block paving, see page 52 and 108 respectively.

# Luxigraze Accessories

Designed to aid the simple installation and maintenance of artificial grass, Luxigraze offers its own range of accessories.

## Installation



### Luxigraze Adhesive - 310ml

- Moisture curing solvent free polyurethane adhesive with a high bond strength, for bonding Luxigraze Artificial Grass.
- Coloured green to blend with the artificial grass.
- Designed to bond the underside of artificial grass to jointing tape and/or the sub base for a secure finish.
- 1 cartridge covers 2-3 linear metres of Luxigraze Jointing Tape.



### Luxigraze Jointing Tape - 20cm wide

- A strong geotextile fabric with a green laminated polyolefinic film to the back, to prevent the penetration of adhesive through to the under surface.
- Designed to be used in conjunction with Luxigraze Adhesive to join Luxigraze Artificial Grass.
- Available in 20m and 100m rolls or cut to length (to the nearest meter).



### Luxigraze U Pins - 150mm x 30mm x 4mm

- Galvanised.
- Heavy duty.
- The best way to secure your artificial grass in to soft ground.
- The u pin will sit below the pile and its green top will be camouflaged.
- Supplied in packs of 10

## Cleaning



### Luxigraze Cleanser - 5Ltr

- A powerful concentrated artificial grass cleanser that is safe and easy to use.
- Designed for use on synthetic grass.
- Has a freshly cut grass fragrance.
- Removes dirt, grease, animal droppings, algae, and moss whilst rejuvenating and restoring the artificial grass back to it's natural appearance.
- It will help suppress bacteria, algae and fungal growth.
- Dilute 1 part cleanser with up to 10 parts of warm water. Apply liberally by mop or spray and work in well with a brush.



### Luxigraze Spot Cleaner - 1Ltr

- A powerful concentrated artificial grass spot cleaner that is safe and easy to use.
- Designed for use on synthetic grass in an easy to use trigger spray bottle.
- Has a freshly cut grass fragrance.
- Removes dirt, grease, animal droppings, algae and moss whilst rejuvenating and restoring the artificial grass back to it's natural appearance.
- It will help suppress bacteria, algae and fungal growth.

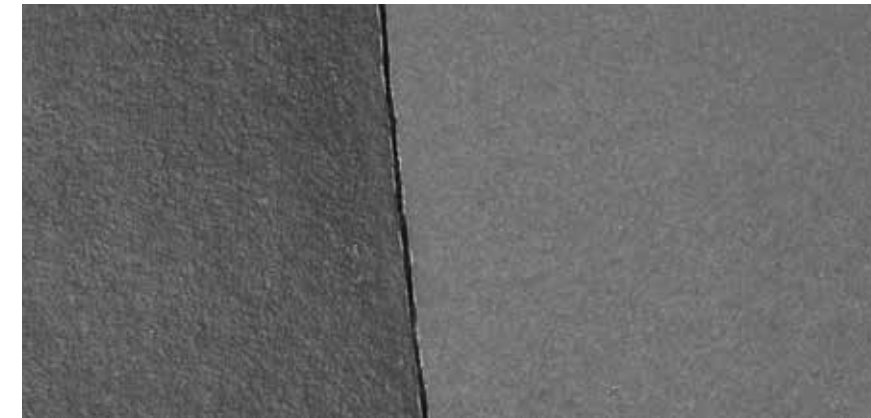

# About Pavetuf

**Pavetuf is a range of products designed to support the installation, maintenance and protection of your hard landscaping.**

An established range of products, Pavetuf includes:

- A priming slurry for the laying of stone and porcelain paving
- Two jointing options and a squeegee to joint paved areas
- Two high performance cutting blades, one for sandstone and one for porcelain
- Two sealants to help protect paving from staining, each offering a different finish and look
- Four specialist cleaners, each designed to tackle different types of stains

**The Pavetuf family of products includes:**

- Installation Products** pg 154
- Sealants** pg 156
- Specialist Cleaners** pg 158

Visit [www.pavetuf.co.uk](http://www.pavetuf.co.uk) for further product information including 'how to' videos and safety data sheets.



# Installation Products



## Pavetuf Priming Slurry

Pavetuf Priming Slurry is a polymer and cementitious slurry, specifically formulated to provide an exceptional bond between a new mortar base and all types of stone and porcelain paving.



## Pavetuf Squeegee

The Pavetuf Squeegee is the ideal tool to apply the Pavetuf Jointing Mortar and Pavetuf Jointing Compound.

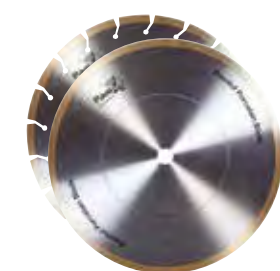

## Pavetuf Blades: Porcelain and Sandstone

We have two specialist blades, one designed to cut sandstone and another to cut porcelain.

### Blade specification:

- 300mm (diameter) x 2.8mm
- 20mm diameter bore
- OSA approved
- EN 13236

## Pavetuf Jointing Mortar

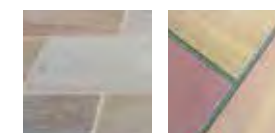
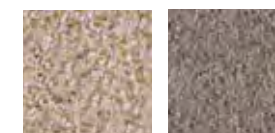

**Silver Grey Gun Metal Grey**

The Jointing Mortar is a professional, rapid setting mortar which provides a contemporary and effective finish to paved areas.

- ✓ Can fill joints from 3mm-50mm and joint depths of up to 200mm
- ✓ Drive on within 4 hours
- ✓ Walk on within 1 hour
- ✓ Mixes quickly on site
- ✓ Very strong -49.6N/mm

### Jointing products compared

To help you select the most appropriate jointing product, please refer to our comparison table below:

Product	Finish	Colours	Application
Jointing Compound	Granular, traditional	Choice of 3; black, grey, buff	Simple and relatively quick, 1 person job. Suitable for DIY and trade professionals.
Jointing Mortar	Smooth, concrete effect	Choice of 2; gun metal grey, silver grey	2 person job, suitable for landscaping professionals. Will require a slurry wash off area.

## Pavetuf Jointing Compound

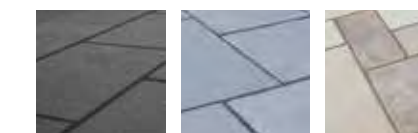

**Black Grey Buff**

An easy to apply all weather Jointing Compound, available in a range of three colours.

- ✓ Use in wet and dry conditions
- ✓ Use with paving joints as narrow as 3mm and maximum widths of 20mm
- ✓ Use with paving joints that have a minimum depth of 20mm
- ✓ Jointed areas can be walked upon after just 18 – 24 hours
- ✓ No waste, can be re-used
- ✓ Easy to apply, durable and eco – friendly



**Watch!**  
 'How to' video  
 available  
 online  
[www.pavetuf.co.uk/news](http://www.pavetuf.co.uk/news)

**Treated with Pavetuf Invisible Sealant**  
 Once a Pavetuf sealant has been applied, they will not allow liquid to soak in immediately, giving time for any spillages to be cleaned away, preventing staining.

**Untreated**

# Sealants

Unlike most other sealants, the water based Pavetuf Invisible and Satin Sealants are unique and fully breathable, allowing efflorescence to escape, whilst preserving the look of the paving and acting as a barrier to protect it against staining. The Pavetuf Invisible and Satin Sealants can be applied as soon as the patio/path/driveway is completed.



## Invisible Sealant

An easy to apply sealant that once applied, dries with a natural, almost invisible finish.



## Satin Sealant

An easy to apply sealant that once applied, dries with a satin, enriched look.

# Specialist Cleaners



## Salt Eraser

After installation, it is common for salt/efflorescence to rise through and sit on the surface of stone paving, causing unsightly white marks. The Salt Eraser is a specific cleaning agent for the removal of salt/efflorescence from stone paths, drives and patios. As it penetrates deep into the stone, it also prevents the reappearance of salt/efflorescence.



Before

After



## Rust Remover

An effective, non corrosive rust stain remover for stone landscaping products.



Before

After



## Green-Off Cleaner

The Green-Off Cleaner is a powerful and high performance cleaner that removes natural and organic soiling from paths, drives and patios, without damaging Pavetuf sealed surfaces.



Before

After



## General Cleaner

The General Cleaner is a general purpose, everyday use cleaner.

We recommend using this product to clean your paved area, prior to using a Pavetuf Sealant.



## Deep Cleaner

The Deep Cleaner is a heavy duty and powerful cleaner for stone, clay and concrete paths, drives and patios, perfect for removing stubborn greasy stains. Although tough on dirt, it is kind to and will not damage Pavetuf sealed surfaces.



# RESISCAPE®

RESIN BOUND AGGREGATES

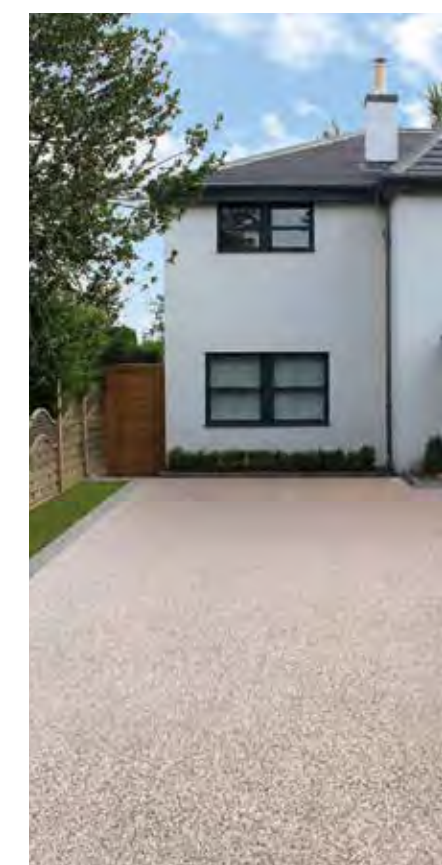

# About Resiscape

Resiscape is quick and easy to install, and with 6 standard colours to choose from, homeowners and specifiers are sure to find the perfect colour to complement their project.

Resiscape can be used in a number of applications, including both domestic driveways and commercial projects.

Please visit the Resiscape website for further product information and installation guide  
[www.resiscape.co.uk](http://www.resiscape.co.uk)



Danish Quartz edged with Natural Paving Midnight Blue kerbs (see page 135).

# Resiscape Resin Bound Aggregate System



Dorset Gold



Black Basalt



Brittany Bronze



Danish Quartz



Red Granite



Silver Blue

Our natural aggregates have been specially dried and are ready to use in pre measured bags. The Resiscape range offers 6 standard colours to suit any project.

If you are looking for something a little different, just let us know, as other colour options are available to special order.

Each Resiscape kit will cover a maximum of 4m<sup>2</sup> at 15mm depth. This is based on laying on a smooth surface and does not take into account surface texture or wastage.

For heavy traffic areas, a thicker layer of the product is required. To ensure the integrity of the system, we recommend a minimum thickness of 15mm. It should be laid at least 3 times the depth of the largest piece of aggregate.

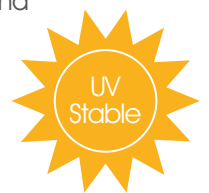

Resin Part A



Resin Part B

## Each 4m<sup>2</sup> kit contains:

- 3 x 25kg Bags of 2-5mm Aggregate
- 1 x 12.5kg Bag of 1-3mm Aggregate\*
- 1 x 6.25kg Bag of C50 Sand
- 1 x Tub of Part A Resin
- 1 x Tub of Part B Resin

\* Please note, the Dorset Gold Aggregate is 1-2mm.  
 Please note the swatches are shown wet and all weights are nominal, with a tolerance of +/- 5%.



# Resiscape Accessories



## Resiscape Primer - 5kg

Resiscape Primer is recommended when installing onto a concrete surface creating a stronger bond between the resin and the sub-base. Each 5kg tin covers around 30m<sup>2</sup> and can be applied using a decorator's roller brush.



## Resiscape Spirit Cleaner - 5kg

The Resiscape Spirit Cleaner is designed for use during the installation of resin bound systems. The cleaner can be used to clean the trowel used for installation as well as the forced action mixer, to prevent the resin/aggregate mix from sticking to these tools and curing. We recommend installers regularly clean the mixer and trowel during installation to aid application.

**Top Tip:** For a very even finish, apply the Resiscape Spirit Cleaner to the trowel and smooth over the laid surface.



## Resiscape Accelerator - 5ltr & 200ml

The Resiscape Accelerator can be used to speed up the curing time of the laid system if the air temperature is cooler than 20°C.

The table below shows how much accelerator needs to be added to the mixture to achieve a curing time of 24 hours. If the accelerator is not used, it can take longer than 24 hours for the system to fully cure in cooler temperatures.

Air Temp (°C)	Resiscape Accelerator Addition Ratio
20°	Accelerator not necessary
17.5°	4.4ml per 6.5kg bucket /4m <sup>2</sup> Kit
15°	9.8ml per 6.5kg bucket /4m <sup>2</sup> Kit
12.5°	16.6ml per 6.5kg bucket /4m <sup>2</sup> Kit
10°	29.3ml per 6.5kg bucket /4m <sup>2</sup> Kit

## Talasey Group general product information and guidance

### About us

Talasey Ltd is one of the UK's leading suppliers of high quality, ethically sourced landscaping products.

We supply a large range of branded landscaping products Natural Paving, Vitripiazza, Baksteen, Pavetuf, Resiscape and Luxigraze, to businesses and their consumers.

We have a team of highly experienced sales and technical staff who are available to provide advice and guidance on our products.

For further information please contact our Internal Sales Team on **0330 333 8030**.

### Purchasing our Products

If you would like to purchase any product in our range, please contact us directly through our Internal Sales Team. We can assist you by providing contact details of our network of stockists, designers and/or installers.

All sales will be subject to applicable Terms and Conditions which are available directly upon request or from your stockist, designer or installer. Samples of our products are available from our stockists.

### Distribution

Talasey Ltd's products are available to our stockists for collection or delivery from our distribution centres at Tilbury, Doncaster, Southampton and Grangemouth.

All products must be checked on arrival and in the unlikely event of products reaching you in a less than satisfactory condition, please refer to your stockist immediately, allowing time for the affected product to be replaced. Do not lay any affected product as we will be unable to consider changing it.

### About our Products

Products and materials, unless otherwise stated, are for domestic landscaping projects.

The product names of our Natural Paving range do not always relate to the geology of the stone.

All of our natural stone products vary in colour and texture. Each individual piece will have distinct markings and may contain natural imperfections and defects. Size variations will also occur and unfortunately this means we cannot guarantee particular sizes. All product dimensions are nominal and calibrated products are subject to variations. Traditional and processed stone materials may result in some delamination of the surface of our products. Many of our products are manufactured in batches, some product characteristics can vary from batch to batch. We would recommend that in order to avoid batch variation enough product for the entire project is ordered in one go.

Please note that customers need to cater for wastage when ordering our products. As a result of the natural characteristics, production and transportation methods of the stone up to 10% of any order may be unusable due to any of the following reasons (including without limitation): chips, blemishes, surface variations, breakages and discolouration. Therefore customers should order an additional 10% in the volume of product required.

A sufficient volume of product (in addition to this 10% uplift) may also be required to cover paver/file positioning and any wastage caused by cuts in the installation process.

Over time, environmental conditions will impact on our products which may attract lichen, algae and/or other organic growths and the appearance of our products may be affected. The correct periodic cleaning of all of our products is recommended.

Due to the composition of natural stone and as its mineral content oxidises, colour variations may also occur. Some stones may suffer from efflorescence or staining from jointing, bedding and fixing compounds/mortar. For further important details about our products please refer to our product brand websites ([www.naturalpaving.co.uk](http://www.naturalpaving.co.uk), [www.vitripiazza.co.uk](http://www.vitripiazza.co.uk), [www.baksteen.co.uk](http://www.baksteen.co.uk), [www.pavetuf.co.uk](http://www.pavetuf.co.uk), [www.resiscape.co.uk](http://www.resiscape.co.uk), and [www.luxigraze.co.uk](http://www.luxigraze.co.uk))

### How to Install and Product Care

Careful consideration must be given to the installation and care of our products. You should seek technical advice at all stages from your stockist, designer or installer as to the care of the particular product you have purchased.

In particular please be aware that you should consider whether the product can be used for the purpose you require. Also please note that some sealers and certain other materials can damage all of our products. Staining of our products can occur if they are not cared for or are used incorrectly and specialist advice should always be sought if you are in any doubt. For further important details about installation and product care please refer to our product brand websites ([www.naturalpaving.co.uk](http://www.naturalpaving.co.uk), [www.vitripiazza.co.uk](http://www.vitripiazza.co.uk), [www.baksteen.co.uk](http://www.baksteen.co.uk), [www.pavetuf.co.uk](http://www.pavetuf.co.uk), [www.resiscape.co.uk](http://www.resiscape.co.uk), and [www.luxigraze.co.uk](http://www.luxigraze.co.uk))

### Landscaping Professionals Scheme

Please note that our scheme is designed to provide a list of members that are independent contractors, installers and designers, to assist in choosing a landscaping professional. Talasey Ltd cannot accept credit or responsibility for their actions and work, we can only guarantee the natural stone products, subject to completion of the required paperwork and criteria.

### Health and Safety

We would recommend that you take extreme care when dealing with our products. In particular, many of our products are heavy and awkward in shape to lift and we recommend that suitable lifting equipment is used.

Crated products should be stacked within the limitations of the ground conditions and of the security of the pallet, we would recommend stacking crates / pallets of product no more than two high.

Appropriate protective clothing should be worn at all times and health and safety legislation should be adhered to when working with our products. When cutting our products either with chisels or rotary disc cutters it is essential that suitable eye protection is worn. Always ensure that suitable respiratory protection is worn to avoid the inhalation of dust particles produced by high speed cutting devices.

It is your responsibility to ensure that you comply with all applicable health and safety legislation and guidelines. For further important details about health and safety please refer to our product brand websites ([www.naturalpaving.co.uk](http://www.naturalpaving.co.uk), [www.vitripiazza.co.uk](http://www.vitripiazza.co.uk), [www.baksteen.co.uk](http://www.baksteen.co.uk), [www.pavetuf.co.uk](http://www.pavetuf.co.uk), [www.resiscape.co.uk](http://www.resiscape.co.uk), and [www.luxigraze.co.uk](http://www.luxigraze.co.uk))

Talasey Ltd adopts a policy of continuous improvement and as such reserve the right to discontinue or modify any products from its range without prior written notification.

## Acknowledgements

We would like to thank all of our Landscaping Professionals scheme members, customers and suppliers who have contributed to the production of this brochure. We would also like to thank Tony McCormack ([www.pavingexpert.com](http://www.pavingexpert.com)) and David Richardson for their support. For full acknowledgement details of the work shown in this brochure, by our Landscaping Professionals, please go to [www.naturalpaving.co.uk/acknowledgements](http://www.naturalpaving.co.uk/acknowledgements)

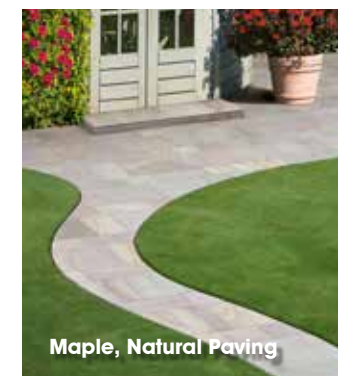

Maple, Natural Paving



Nuvola, Vitripiazza

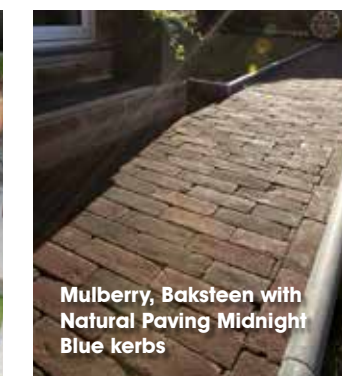

Mulberry, Baksteen with Natural Paving Midnight Blue kerbs

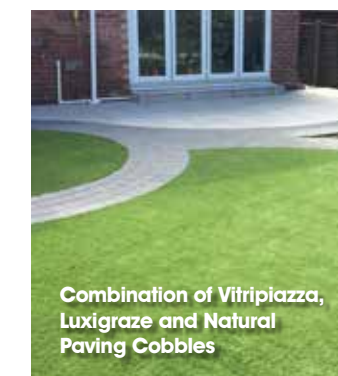

Combination of Vitripiazza, Luxigraze and Natural Paving Cobbles

This brochure and all of the information within it is copyright of Talasey Ltd 2018.

Brochure designed by Punch Creative, Leeds - [www.punch-creative.co.uk](http://www.punch-creative.co.uk)

All images included in this brochure are the copyright of Talasey Ltd. Unauthorised reproduction of any image is forbidden unless prior permission has been granted by Talasey Ltd. Information is considered accurate at the time of going to print, and Talasey Ltd cannot be held responsible for any errors or omissions. Photographs have been used as a guide to product identification only and may not be accurate in detail or colour and there may be some colour variations between photographs, compared to the actual product. In the interest of product improvements we reserve the right to change colours, design and specifications without prior notice. Copyright 2018.

For further important details about our Natural paving stone products: purchasing and receiving them; their properties; installation; product care and; health and safety issues, please refer to our 'Understanding and Installing Natural Stone Paving' guide.

Download our  
'Understanding  
and Installing  
Natural Stone  
Paving' guide





**NATURAL PAVING**  
be inspired...



**Luxigraze**  
ARTIFICIAL GRASS



**VITRIPIAZZA**  
Vitrified Porcelain Paving



**RESISCAPE**  
RESIN BOUND AGGREGATES



**BAKSTEEN**  
CLAY BRICKS AND PAVERS



**Pavetuf**

**The UK's leading independent supplier of landscaping solutions**

**Tel:** 0330 333 8030    **Fax:** 0330 333 8040

**Email:** [info@talasey.co.uk](mailto:info@talasey.co.uk)

**[www.talasey.co.uk](http://www.talasey.co.uk)**

Talasey Ltd, Talasey House, Belton Road,  
Sandtoft, Doncaster, DN8 5SX.

  
**TALASEY**  
GROUP

Your local stockist