

The Velux logo is a red rectangle with the word "VELUX" in white, bold, sans-serif capital letters. A registered trademark symbol (®) is located at the top right of the red rectangle. The background of the entire page is a bright, airy interior space featuring a dining table with wooden chairs, a large glass door leading to a garden, and several skylights in the ceiling. The scene is bathed in natural light, creating a warm and inviting atmosphere.

**VELUX®**

# Product Brochure

UK Price List (excludes VAT) 6th February 2017

[velux.co.uk](http://velux.co.uk)



# Bring some innovation and inspiration to your next project

For over 75 years, VELUX® has led the way in designing innovative roof windows, developing an outstanding, market-leading product range that has helped to fill millions of homes with more daylight and fresh air. Which means that when it comes to your next project, you can perfectly tailor your roof windows to suit your home and your family's needs.

VELUX roof windows can bring in twice the amount of daylight into your extension, compared to vertical windows of the same size, or transform your loft into a brand new space.

Create a better indoor climate by replacing your old roof windows with VELUX roof windows. Our VELUX INTEGRA® electric and solar options put control of daylight and fresh air at your fingertips, and adds a real wow-factor to your home.

Enjoy more control over the amount of daylight, temperature, and privacy in your home with the extensive range of VELUX blinds, awning blinds or shutters.

In keeping with our commitment to developing exciting new products, this year we are introducing a NEW curved glass rooflight into the market.

Explore our full range of sizes, options and finishes – all backed by the expertise and support of our technical team, and bring some truly innovative ideas to your next project.



## Contents

### Your ideal solution

First class service	4-5
Extensions and replacements	6-7
Features and finishes	8-9
Explore the possibilities	10-11

### Design inspiration

Extension	12-13
Flat roof extension	14-15
Loft conversion	16-17
Replacement roof windows	18-19

### VELUX roof windows

Centre-pivot roof windows	20-21
VELUX INTEGRA® roof windows	22-23
Top-hung roof windows	24-25
Conservation roof windows	26-27

### VELUX CABRIO® balcony

28-29

### Sloping combinations

Sloping and vertical combinations	30
Sloping and fixed combinations	31

### VELUX flat roof windows

Curved and flat glass rooflights	32-35
Flat roof domes	36-37

### VELUX Modular Skylights

38-39

### VELUX sun tunnels

40-41

### Smoke ventilation and rooflights

Smoke ventilation system	42
Rooflights for uninhabited spaces	43

### Replacing and upgrading

Replacing existing roof windows	44-45
Upgrading existing roof windows	46
Upgrading glazing	47

### Installation products

48-49

### Flashings

Flashings	50
Recessed and standard flashings	51
Twin and combination flashings	52-53

### Blinds and Accessories

Blinds and shutters	54-61
Accessories	62



Extended product brochure available online.  
Visit [brochures.velux.co.uk](http://brochures.velux.co.uk)

Advice on product selection and installation instructions are also available on our website [velux.co.uk](http://velux.co.uk)



## FIRST CLASS SERVICE

# Our team is part of your team

We do more than simply supply market-leading roof windows. Our quality service matches our quality products. That's why we believe in working in partnership with you to ensure the smoothest installation and finest end result – whether you're fitting brand new roof windows or replacing existing ones.



**Certified Installer**  
Find a VELUX Certified Installer near you, visit [velux.co.uk/find-an-installer](http://velux.co.uk/find-an-installer)



### The UK's Number 1 in roof windows because...

- We've been at the very forefront of innovative design in roof windows for over 75 years.
- We're tried, tested and guaranteed.
- We use cutting edge manufacturing techniques to ensure quality and consistency.
- We have a zero defect philosophy embedded into our workforce, as well as stringent final inspections, ensuring products arrive with you in perfect condition.
- VELUX products are rigorously tested in Northern Europe's largest wind tunnel and are backed by a comprehensive guarantee.
- Our focus is to provide products you can depend on, year in year out.



This gives you and your customers long-term peace of mind when you choose VELUX.

Please visit [velux.co.uk/registration](http://velux.co.uk/registration) to register your VELUX roof window guarantee and receive information on future special offers.



#### Expert technical and aftersales service

Whenever you have any questions, you can always call on our expert support team for technical support and specification advice. They're here to give you in-depth assistance on planning, installation and aftercare.

Tel: 01592 778 225



#### The tools to build your project

We offer you the best products on the market – we also understand the importance of helping you choose the best solution for your project. Our first class marketing materials provide inspiration and give you opportunities to enhance and expand your project.



#### Reliable logistics

A well-run project requires the supplies you need to be on-site when you need them. With a vast amount of our products available in two working days, you can rely on us to deliver quickly and on time. Our logistics services also include advice and support on handling and storage.



#### Dedicated field support

With over 1,000 years combined experience, our team in the UK and Ireland strive to constantly improve the service you receive. As well as advice by phone, our nationwide service technicians and field sales teams are happy to offer hands-on support throughout the year.





## Bring in more natural daylight to transform your extension

Everyone has an idea of what they'd do with some extra space in their home.

It could be a dedicated space for the little ones to play in, or an expanded kitchen/dining room where the whole family can get together.

Here are some reasons why adding VELUX roof windows into an extension can help transform your house into a dream home.

- VELUX roof windows can bring in **TWICE as much daylight** as vertical windows of the same size by allowing light to penetrate deeper into the original part of the home.

Without VELUX roof windows the original room can become darker as the natural light source is moved further away.

- If an extension doubles as a kitchen, eliminating heat and food smells is important. VELUX INTEGRA® solar and electric roof windows, perfect for out-of-reach situations, make **ventilating your space** easier and smarter thanks to the innovative VELUX INTEGRA® control pad. Our white polyurethane finish is maintenance-free, also ideal for out-of-reach situations and rooms with high levels of humidity.

- Complement the interior decor and control the amount of daylight and temperature within an extension by adding internal and external **VELUX blinds, awning blinds and shutters** that can be operated by the VELUX INTEGRA® control pad.

In a sloping roof, VELUX roof windows allow light to flood further into your extension.

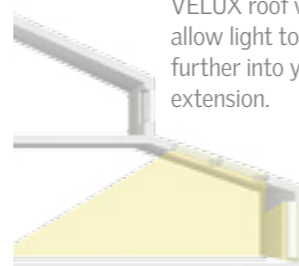

## Replace your old roof windows to give your home a new lease of life

Replacing your old roof windows with new VELUX roof windows won't just make your home look better. You can improve your indoor climate, energy efficiency and the amount of daylight you enjoy. VELUX have provided the same range of roof window sizes for the last 40 years, so it is usually very easy to find a direct size match. It's quicker and more straightforward than you think!

- You can now choose from a much wider range of glazing options, including enhanced noise reduction, privacy, security and triple glazing. Plus there's more choice of finishes and methods of operation than ever before. It's never been easier to find **the perfect VELUX solution** for your home.
- **Increase your home's energy efficiency** and help reduce household bills by replacing an old roof window with a new VELUX roof window. VELUX ThermoTechnology™ features innovative high performance materials, meaning less energy is used and warmth is kept in the home.
- VELUX roof windows can be replaced in as little as four hours. All work can be carried out from inside of the room without disrupting the current internal finish and no scaffolding is necessary – it's **less hassle** than you think.

See our  
easy guide for  
replacement  
size codes  
on page 63



# Our product features at a glance

Our highly engineered roof windows have the latest technology built in. Our research and development teams are continuously refining products to improve performance.

The following features come as standard with all of our roof windows and are designed to make installation and operation easier, as well as ensuring our products look their best.

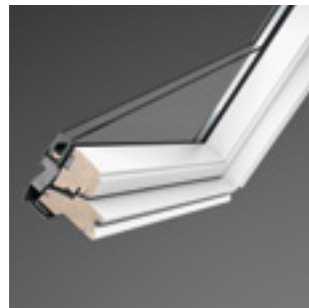

All roof windows (excluding rooflights for uninhabited spaces) have laminated safety glazing as standard. In case of breakage, this prevents glass falling into your home.

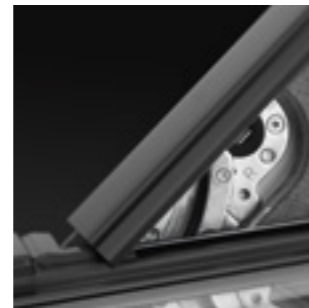

Our maintenance-free, high quality pivot hinges are designed with innovative technology, ensuring stability.



VELUX ThermoTechnology™ features high performance materials in the roof window construction. This ensures you use less energy whilst keeping the warmth in your home.



For easy cleaning of the outside pane, the barrel bolt locks the roof window in a 180° position. Now both hands are free for you to clean the outer pane easily and safely.



The same bracket is used for both recessed and standard installations. A simple red and blue line system shows where the bracket should be installed. You can be confident of a straightforward installation every time.



The unique brushed aluminium ventilation flap makes it possible to let fresh air into your home, even when the roof window is securely closed or when you are away or sleeping, without having to worry about security or bad weather.

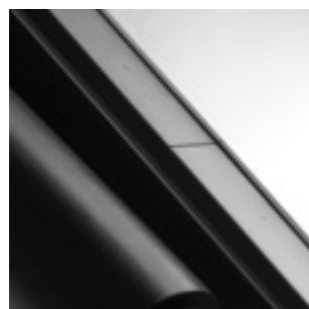

Click-on covers make your installation easier, faster and safer, by reducing the number of screws required on-site.



Our pre-installed, patented mounting brackets come as standard on every VELUX roof window and fit any of our VELUX blinds, making installation as straightforward as possible.

Pick&Click!®

# The finishing touch to suit your home

## THREE INTERNAL FINISH OPTIONS

Lighter, brighter modern living spaces are more popular than ever. To ensure you have the means to make the most of your project, we offer three internal finish options. All finishes have the same high VELUX quality combined with:

- Laminated safety glass as standard.
- Straightforward installation.
- Excellent value for money.
- Full range available and in stock.
- Short delivery time.

## WHITE POLYURETHANE FINISH

- Wooden core encased in moisture-resistant white polyurethane. The first choice for humid rooms such as kitchens and bathrooms.
- Maintenance-free, which is ideal for out-of-reach areas.
- Thermally moulded timber core delivers improved insulation.
- Bright white finish with no visible joints, perfect for modern homes.



## WHITE PAINTED FINISH

- Painted before assembly for a flawless finish and outstanding durability.
- Bright white finish with discreet wood grain matches perfectly with modern interiors.
- Lower maintenance than pine finish roof windows.
- Highly UV resistant, water-based breathable paint to preserve a crisp, bright look.



## PINE FINISH

- Matches perfectly with traditional interiors.
- Protective triple coat clear lacquer helps to preserve the timber of the window.





# Explore the possibilities...

Every VELUX product you specify will do a great job – but before you start, it's worth considering all the available solutions for the space you are creating. By choosing the right operation, glazing and blinds you can make a big difference to your project and how the room functions.

## Operation

### Centre-pivot

Centre-pivot roof windows are operated via the top control bar, making it easy to open, even with furniture below the window.

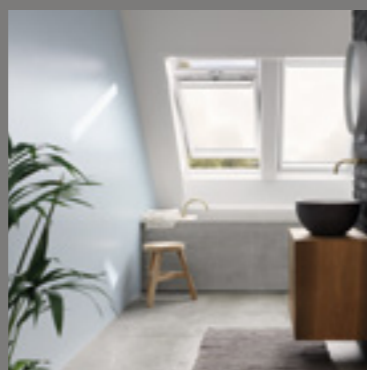

### Top-hung

Top-hung roof windows are operated by a handle at the bottom and open outwards, allowing you to take advantage of uninterrupted views and a feeling of extra space.



Or upgrade to this from an extra  
**£92\***

### VELUX INTEGRA®

Control of your VELUX INTEGRA® roof windows is at your fingertips, thanks to an innovative VELUX INTEGRA® control pad. Ideal for those out-of-reach spots, they're the ultimate choice for fresh air and better indoor comfort.



Or upgrade to this from an extra  
**£300\***

See all our roof window options on pages 20-31.

## Glazing

### 70 pane – Safety glazing U-value 1.3 W/m²K

Laminated safety glazing comes as standard. In case of accidental breakage, this prevents glass falling into your room.



### 60 pane – Noise reduction glazing U-value 1.3 W/m²K

All the benefits of 70 pane, plus reduces traffic and other outside noise, including the sound of rain and hail. Easy-to-clean coating that repels dust and debris.



Or upgrade to this from an extra  
**£60\***

### 66 pane – Energy efficiency glazing U-value 1.0 W/m²K

Triple glazed unit with enhanced energy efficiency. Anti-dew coating that provides a clearer view by reducing the number of hours dew is present on the glass.



Or upgrade to this from an extra  
**£150\***

For more glazing options visit pages 20-25.

## Blinds

### Blackout energy blinds

The double-pleated blackout cloth with a honeycomb structure offers exceptional insulation (by up to 26%) and fabric offers complete blackout.



Available from  
**£76\***

### Duo blackout blinds

A blackout blind and a pleated blind in one, offering the best of both worlds; blackout at any time and softly diffused natural light all day.



Available from  
**£82\***

### VELUX INTEGRA® solar and electric operated blinds

Allow full control of daylight with just one touch using the VELUX INTEGRA® control pad. Available for blackout, roller, pleated and light dimming energy blinds in a full range of colours.

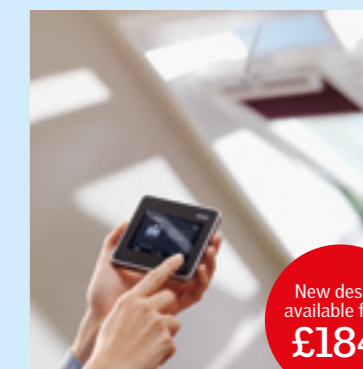

New design available from  
**£184\***

Check out the full blinds range on pages 54-61.



## Extension – Extra living space

### OPEN PLAN EXTENSION

VELUX INTEGRA® roof windows transformed this family room into a stunning, bright and welcoming living space. Without roof windows, the original part of this building lacked direct sunlight because light from the vertical patio doors has a limited reach. Now it's an ideal space for entertaining and relaxing.



VELUX INTEGRA® solar powered white painted roof windows (GGL PK08 207030).  
Fitted with external awning blinds (MSL PK08 5060).

### VELUX RECOMMEND

#### VELUX INTEGRA®

Solar powered. Ideal for out-of-reach situations.

#### WHITE PAINTED

Matches perfectly with modern interiors.

#### 70 PANE

Safety glazing, prevents glass falling into your home in case of breakage.



### KEY BENEFITS

- Maximises the light in a pitched roof room.
- Fresh air can be controlled.
- Roof windows and blinds can be opened and closed easily using the same VELUX INTEGRA® control pad.

### LIKE WHAT YOU SEE?

Find these products in this brochure:  
VELUX INTEGRA® →

Page  
22

### HAVE YOU CONSIDERED?

White polyurethane finish. Maintenance-free which is ideal for out-of-reach situations.

**UPGRADE FROM £46\***

66 pane.

Enhanced energy efficiency glazing that offers excellent levels of thermal insulation.

**UPGRADE FOR £150\***

### VELUX BLINDS

Control the amount of daylight and the temperature within a room by adding a VELUX blind or shutter:

Solar roller blinds  
**FROM £208\***

Solar awning blinds  
**FROM £354\***

For further inspiration you can view more case studies at [velux.co.uk/extensions](http://velux.co.uk/extensions)

\*per roof window.



## Flat roof extension – Adding the natural daylight you're looking for

### FLAT ROOF EXTENSION

A gloomy flat roof kitchen, that offered very little in the way of natural daylight, was transformed using a VELUX flat roof window. Fresh air and light now flood the space and family members can now spend time relaxing, cooking and eating. The flat rooflight is out-of-reach, but because it's a VELUX INTEGRA® flat rooflight, the control is at your fingertips, and it can be opened at a moment's notice.



NEW VELUX flat glass rooflight (CVP 100150 0673QV base unit and ISD 100150 2093 top cover)

### VELUX RECOMMEND

#### VELUX FLAT GLASS ROOFLIGHTS

The functionality of a traditional dome but with an attractive glass cover making the outside look as good as the inside.

Electric operation is recommended to provide ventilation at your fingertips.

### KEY BENEFITS

- Rain sensors feature on all VELUX INTEGRA® flat roof windows, which automatically close in the event of rain.
- Maintenance free PVC construction.
- Wide range of sizes available.



### HAVE YOU CONSIDERED?

NEW VELUX curved glass rooflights available from Spring 2017.  
**UPGRADE FROM £63\***

### LIKE WHAT YOU SEE?

Find these products in this brochure:  
VELUX flat roof windows →

Page  
32

### VELUX BLINDS

Control the amount of daylight and the temperature within a room by adding a VELUX blind or shutter:

Electric pleated blinds  
**FROM £261\***

Solar pleated blinds  
**FROM £286\***

For further inspiration you can view more case studies at [velux.co.uk/extensions](http://velux.co.uk/extensions)

\*per roof window.



## Loft conversion – Utilising every square metre

### BATHROOM

This beautiful en-suite was created by utilising an unused loft space. Using two VELUX centre-pivot roof windows rather than just one adds a real wow factor. The option of adding obscure glazing ensures privacy while still letting in the light.



VELUX centre-pivot manually operated white polyurethane roof windows (GGU MK08 0034)

### VELUX RECOMMEND

#### CENTRE-PIVOT

Top control bar makes it easy to open, even with furniture beneath the roof window.

#### WHITE POLYURETHANE

Moisture resistant polyurethane finish is ideal for humid rooms such as bathrooms.

#### 34 PANE

Obscure glazing is ideal for privacy.

### KEY BENEFITS

- Controllable ventilation.
- Maintenance-free finish.
- Privacy can be protected and maximum light maintained with optional obscure glass.



### HAVE YOU CONSIDERED?

VELUX INTEGRA® solar or electrically operated. Ideal for out-of-reach situations.

**UPGRADE FOR £300\***

### LIKE WHAT YOU SEE?

Find these products in this brochure:  
Centre-pivot roof windows →

Page  
20

### VELUX BLINDS

Control the amount of daylight and the temperature within a room by adding a VELUX blind or shutter:

Venetian blinds  
**UPGRADE FROM £76\***

\*per roof window.



# Replacement roof windows – Creating a new lease of life

## BEDROOM/PLAYROOM

This playroom has been given a new lease of life by replacing an old roof window with a new VELUX roof window. The room is now warmer thanks to improved insulation, making the space more energy efficient, and brighter due to the larger glazed area.



## VELUX RECOMMEND

### TOP-HUNG

Opens outwards for an unobstructed view and feeling of extra space.

### WHITE PAINTED

Matches perfectly with modern interiors.

### 60 PANE

Enhanced noise reduction for a good night's sleep.

### REPLACEMENT FLASHING

Allows old roof windows to be replaced without disturbing the interior lining.



## KEY BENEFITS

- Can be replaced from inside the room without disrupting current internal finish – no scaffolding necessary.
- Same standard VELUX sizes available.
- Replaced in as little as four hours.

## LIKE WHAT YOU SEE?

Find these products in this brochure:  
Top-hung roof windows →

Page  
24

## HAVE YOU CONSIDERED?

White polyurethane finish. Maintenance-free and perfect for contemporary interiors and white ceilings.

**UPGRADE FROM £46\***

## VELUX BLINDS

Control the amount of daylight and the temperature within a room by adding a VELUX blind or shutter:

Blackout blind  
**UPGRADE FROM £60\***

\*per roof window.

Shown on right, VELUX top-hung manually operated white painted roof windows (GPL MK08 2060)





# VELUX centre-pivot roof windows

The classic choice

Featured: VELUX centre-pivot white painted roof windows (GGL PK10 2060)

## VELUX centre-pivot roof windows

		55 x 78	55 x 98	55 x 118	78 x 98	66 x 118	78 x 118	78 x 140	134 x 98	94 x 140	114 x 118	94 x 160	134 x 140
External frame size (nominal w x h) cm		CK02	CK04	CK06	MK04	FK06	MK06	MK08	UK04	PK08	SK06	PK10	UK08
<b>White polyurethane</b>													
<b>GGU 0070</b> U-value 1.3 W/m <sup>2</sup> K	Laminated inner, toughened outer pane.	£274	£289	£302	£314	£336	£355	£393	£453	£459	£472	£484	£550
<b>GGU 0060</b> U-value 1.3 W/m <sup>2</sup> K	Laminated inner, toughened outer pane. Easy-to-clean coating, enhanced noise reduction.	£334	£349	£362	£374	£396	£415	£453	£513	£519	£532	£544	£610
<b>GGU 0066</b> U-value 1.0 W/m <sup>2</sup> K	Triple glazed. Laminated inner, toughened outer pane. Anti-dew* and easy-to-clean coating.	£424	£439	£452	£464	£486	£505	£543	£603	£609	£622	£634	£700
<b>GGU 0062</b> U-value 0.81 W/m <sup>2</sup> K	Triple glazed. Laminated inner, toughened outer with anti-dew* coating. Further enhanced noise reduction.	£524	£539	£552	£564	£586	£605	£643	-	£709	£722	£734	-
<b>GGU 0034</b> U-value 1.3 W/m <sup>2</sup> K	Obscure laminated inner, toughened outer pane.	£314	£329	£342	£354	£376	£395	£433	£493	£499	£512	£524	£590
<b>GGU 0070Q</b> U-value 1.3 W/m <sup>2</sup> K	Laminated inner, toughened outer pane. Enhanced security.	£452	£468	-	£493	£515	£534	£572	£632	£638	£651	£664	£730
<b>White painted</b>													
<b>GGL 2070</b> U-value 1.3 W/m <sup>2</sup> K	Laminated inner, toughened outer pane.	£228	£241	£252	£262	£280	£296	£328	£377	£383	£393	£403	£459
<b>GGL 2060</b> U-value 1.3 W/m <sup>2</sup> K	Laminated inner, toughened outer pane. Easy-to-clean coating, enhanced noise reduction.	£288	£301	£312	£322	£340	£356	£388	£437	£443	£453	£463	£519
<b>GGL 2066</b> U-value 1.0 W/m <sup>2</sup> K	Triple glazed. Laminated inner, toughened outer pane. Anti-dew* and easy-to-clean coating.	£378	£391	£402	£412	£430	£446	£478	£527	£533	£543	£553	£609
<b>GGL 2062</b> U-value 0.83 W/m <sup>2</sup> K	Triple glazed. Laminated inner, toughened outer with anti-dew* coating. Further enhanced noise reduction.	£478	£491	£502	£512	£530	£546	£578	-	£633	£643	£653	-
<b>GGL 2070Q</b> U-value 1.3 W/m <sup>2</sup> K	Laminated inner, toughened outer pane. Enhanced security.	£376	£389	-	£410	£428	£444	£476	£525	£531	£541	£551	£607
<b>Pine</b>													
<b>GGL 3070</b> U-value 1.3 W/m <sup>2</sup> K	Laminated inner, toughened outer pane.	£219	£231	£241	£252	£269	£284	£314	£362	£367	£377	£387	£440

- ▶ All roof windows have a delivery time of 2 days except '66' and '62' pane windows which are 7 days and '70Q' pane windows which are 11 days (white painted) and 16 days (white polyurethane).
- ▶ Delivery time is in working days from receipt of orders placed before 4pm (UK) and 3pm (NI).

\*Anti-dew coating reduces number of hours external condensation is present.

### Roof pitch



Suitable for roof pitches between 15° and 90°.

### Benefits of centre-pivot roof windows

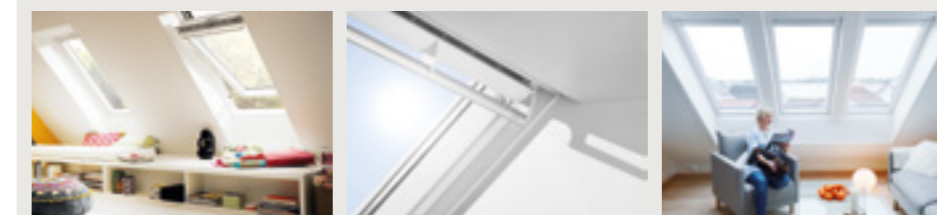

Convenient – even with furniture placed beneath the roof window.

Easy to open and quick to close with the top control bar.

Low installation allows for easier operation and better views.







## VELUX INTEGRA® electric and solar centre-pivot roof windows

The ideal solution for out-of-reach situations

Featured: VELUX INTEGRA® electric centre-pivot roof windows (GGU PK08 007021U)

### VELUX INTEGRA® electric and solar centre-pivot roof windows

External frame size (nominal w x h) cm		55 x 78	55 x 98	55 x 118	78 x 98	66 x 118	78 x 118	78 x 140	134 x 98	94 x 140	114 x 118	94 x 160	134 x 140
Code	Glazing	CK02	CK04	CK06	MK04	FK06	MK06	MK08	UK04	PK08	SK06	PK10	UK08
<b>VELUX INTEGRA® electric</b>													
<b>White polyurethane</b>													
<b>GGU 007021U</b>	Laminated inner, toughened outer pane.	£574	£589	£602	£614	£636	£655	£693	£753	£759	£772	£784	£850
U-value 1.3 W/m²K													
<b>GGU 006021U</b>	Laminated inner, toughened outer pane. Easy-to-clean coating, enhanced noise reduction.	£634	£649	£662	£674	£696	£715	£753	£813	£819	£832	£844	£910
U-value 1.3 W/m²K													
<b>GGU 006621U</b>	Triple glazed. Laminated inner, toughened outer pane. Anti-dew* and easy-to-clean coating.	£724	£739	£752	£764	£786	£805	£843	£903	£909	£922	£934	£1,000
U-value 1.0 W/m²K													
<b>White painted</b>													
<b>GGL 207021U</b>	Laminated inner, toughened outer pane.	£528	£541	£552	£562	£580	£596	£628	£677	£683	£693	£703	£759
U-value 1.3 W/m²K													
<b>GGL 206021U</b>	Laminated inner, toughened outer pane. Easy-to-clean coating, enhanced noise reduction.	£588	£601	£612	£622	£640	£656	£688	£737	£743	£753	£763	£819
U-value 1.3 W/m²K													
<b>GGL 206621U</b>	Triple glazed. Laminated inner, toughened outer pane. Anti-dew* and easy-to-clean coating.	£678	£691	£702	£712	£730	£746	£778	£827	£833	£843	£853	£909
U-value 1.0 W/m²K													
<b>Pine</b>													
<b>GGL 307021U</b>	Laminated inner, toughened outer pane.	£519	£531	£541	£552	£569	£584	£614	£662	£667	£677	£687	£740
U-value 1.3 W/m²K													

<b>VELUX INTEGRA® solar powered</b>													
<b>White polyurethane</b>													
<b>GGU 007030</b>	Laminated inner, toughened outer pane.	£608	£623	£636	£648	£670	£689	£727	£787	£793	£806	£818	£884
U-value 1.3 W/m²K													
<b>GGU 006030</b>	Laminated inner, toughened outer pane. Easy-to-clean coating, enhanced noise reduction.	£668	£683	£696	£708	£730	£749	£787	£847	£853	£866	£878	£944
U-value 1.3 W/m²K													
<b>GGU 006630</b>	Triple glazed. Laminated inner, toughened outer pane. Anti-dew* and easy-to-clean coating.	£758	£773	£786	£798	£820	£839	£877	£937	£943	£956	£968	£1,034
U-value 1.0 W/m²K													
<b>White painted</b>													
<b>GGL 207030</b>	Laminated inner, toughened outer pane.	£562	£575	£586	£596	£614	£630	£662	£711	£717	£727	£737	£793
U-value 1.3 W/m²K													
<b>GGL 206030</b>	Laminated inner, toughened outer pane. Easy-to-clean coating, enhanced noise reduction.	£622	£635	£646	£656	£674	£690	£722	£771	£777	£787	£797	£853
U-value 1.3 W/m²K													
<b>GGL 206630</b>	Triple glazed. Laminated inner, toughened outer pane. Anti-dew* and easy-to-clean coating.	£712	£725	£736	£746	£764	£780	£812	£861	£867	£877	£887	£943
U-value 1.0 W/m²K													

▶ All roof windows have a delivery time of 2 days except '66' pane windows and GGL 206030 which are 11 days.  
▶ Delivery time is in working days from receipt of orders placed before 4pm (UK) and 3pm (NI).

\*Anti-dew coating reduces number of hours external condensation is present.

#### Roof pitch



Suitable for roof pitches between 15° and 90°.

#### Operation



#### ELECTRIC

- Control pad operation can be used within 20m of roof windows.
- Fully integrated motor which runs almost without a sound.



#### SOLAR POWERED

- All the same features as VELUX INTEGRA® electric roof windows, but powered by the sun.
- PV solar cell on external window frame requires direct exposure to sunlight.

#### BENEFITS

- Ideal for out-of-reach situations.
- The VELUX INTEGRA® control pad with touch screen and swipe function uses icons for easy and intuitive control. Provides fresh air, better indoor comfort and home security. Included with every VELUX INTEGRA® roof window.
- Rain sensors feature on all VELUX INTEGRA® roof windows, automatically closing in the event of rain.





## VELUX top-hung roof windows

The perfect choice for loft conversions

Featured: VELUX top-hung roof windows (GPL PK10 2060 and additional fixed elements GIL PK34 2060)

### VELUX top-hung roof windows

		55 x 98	55 x 118	78 x 98	66 x 118	78 x 118	78 x 140	134 x 98	94 x 140	114 x 118	94 x 160	134 x 140	
External frame size (nominal w x h) cm	Code	Glazing	CK04	CK06▲	MK04▲	FK06▲	MK06▲	MK08▲	UK04▲	PK08▲	SK06▲	PK10▲	UK08▲
White polyurethane													
GPU 0070	U-value 1.3 W/m²K	Laminated inner, toughened outer pane.	£378	£395	£411	£440	£465	£514	-	£601	£617	£633	£720
GPU 0060	U-value 1.3 W/m²K	Laminated inner, toughened outer pane. Easy-to-clean coating, enhanced noise reduction.	£438	£455	£471	£500	£525	£574	-	£661	£677	£693	£780
GPU 0066	U-value 1.0 W/m²K	Triple glazed. Laminated inner, toughened outer pane. Anti-dew* and easy-to-clean coating.	£528	£545	£561	£590	£615	£664	-	£751	£767	£783	£870
GPU 0062	U-value 0.85 W/m²K	Triple glazed. Laminated inner, toughened outer pane. Anti-dew* coating. Further enhanced noise reduction.	£628	£645	£661	£690	£715	£764	-	£851	£867	£883	-
GPU 0034	U-value 1.3 W/m²K	Obscure laminated inner, toughened outer pane.	£418	£435	£451	£480	£505	£554	-	£641	£657	£673	£760
White painted													
GPL 2070	U-value 1.3 W/m²K	Laminated inner, toughened outer pane.	£333	£347	£362	£387	£409	£452	£521	£528	£542	£557	£633
GPL 2060	U-value 1.3 W/m²K	Laminated inner, toughened outer pane. Easy-to-clean coating, enhanced noise reduction.	£393	£407	£422	£447	£469	£512	£581	£588	£602	£617	£693
GPL 2066	U-value 1.0 W/m²K	Triple glazed. Laminated inner, toughened outer pane. Anti-dew* and easy-to-clean coating.	£483	£497	£512	£537	£559	£602	£671	£678	£692	£707	£783
Pine													
GPL 3070	U-value 1.3 W/m²K	Laminated inner, toughened outer pane.	£319	£333	£347	£371	£392	£434	£500	£507	£521	£535	£607

▲ Sizes suitable for emergency escape requirements.

- ▶ All roof windows have a delivery time of 2 days except GPU 0066 and GPU 0062 which are 7 days and GPL 2066 windows which are 11 days.
- ▶ Delivery time is in working days from receipt of orders placed before 4pm (UK) and 3pm (NI).

\*Anti-dew coating reduces number of hours external condensation is present.

#### Roof pitch



Suitable for roof pitches between 15° and 55°. Also suitable for roof pitches between 55° and 75° with special springs – please specify when ordering.

#### Opening Options

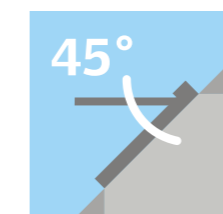

##### 45° OPENINGS

- GPU and GPL roof windows open to any position up to 45°.



##### EMERGENCY ESCAPE

- Due to the unrestricted opening area, a larger selection of roof windows are suitable for emergency escape purposes.

#### Benefits of top-hung roof windows



Enjoy panoramic, unobstructed views and maximise the amount of natural daylight.

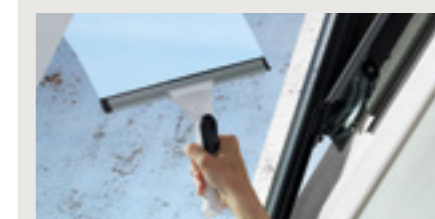

Rotates 180° for easy cleaning from the inside.



Convenient bottom operation – the perfect choice for loft conversions with windows in easy reach.





## VELUX conservation roof windows

For traditional buildings

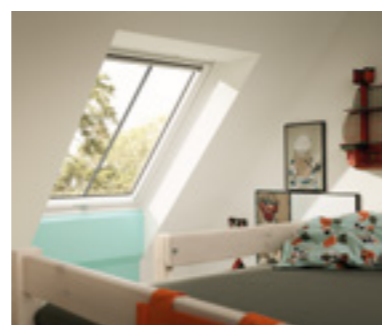

Conservation packages include:

- Roof windows with laminated glazing as standard for safety.
- Recessed flashings available for a more streamlined external appearance.
- Insulation collar and underfelt collar provided for a weathertight and energy efficient installation.

When planning dictates that a window of traditional external appearance is required, conservation roof windows should be considered. All of our conservation roof windows have the same technical features of a VELUX roof window but in a traditional black conservation style.

- Available in either centre-pivot or top-hung.
- Black external profiles and glazing bar. RAL 9005.
- Recessed installation for slate and tiled roofs.
- Top-hung roof windows listed below are suitable for emergency escape.
- Other sizes and glazing options available – contact us for further information.

### Conservation roof windows

External frame size (nominal w x h) cm

Code	Description	CK04	CK06	FK06	MK06	MK08	UK04
<b>Centre-pivot white painted</b>							
GGL SD5N2 U-value 1.3 W/m²K	GGL 2570 roof window + EDN recessed flashing for slate up to 8mm thick (min 20° roof pitch)	£438	£455	£495	£558	£601	£726
GGL SD5P2 U-value 1.3 W/m²K	GGL 2570 roof window + EDP flashing for plain tiles up to 14mm thick (min 25° roof pitch)	£400	£416	£453	£514	£554	£673
GGL SD5W2 U-value 1.3 W/m²K	GGL 2570 roof window + EDW flashing for tiles up to 120mm in profile (min 15° roof pitch)	£400	£416	£453	£514	£554	£673
GGL SD5J2 U-value 1.3 W/m²K	GGL 2570 roof window + EDJ recessed flashing for tiles up to 90mm in profile (min 20° roof pitch)	£438	£455	£495	£558	£601	£726
<b>Top-hung white painted. For roof pitches of 55°-75°, please specify special springs when ordering.</b>							
GPL SD5N2 U-value 1.3 W/m²K	GPL 2570 roof window + EDN recessed flashing for slate up to 8mm thick (min 20° roof pitch)	-	-	-	-	£725	-
GPL SD5P2 U-value 1.3 W/m²K	GPL 2570 roof window + EDP flashing for plain tiles up to 14mm thick (min 25° roof pitch)	-	-	-	-	£678	-
GPL SD5W2 U-value 1.3 W/m²K	GPL 2570 roof window + EDW flashing for tiles up to 120mm in profile (min 15° roof pitch)	-	-	-	-	£678	-
GPL SD5J2 U-value 1.3 W/m²K	GPL 2570 roof window + EDJ recessed flashing for tiles up to 90mm in profile (min 20° roof pitch)	-	-	-	-	£725	-



- ▶ All roof windows have a delivery time of 2 days.
- ▶ Delivery time is in working days from receipt of orders placed before 4pm (UK) and 3pm (NI).

### Optional glazing bars for standard VELUX roof windows



The requirements from conservation officers throughout the country differ and the black finish featured within our conservation roof window packages may not be required in your area.

Consult your local conservation officer and find out if you can create a traditional appearance by adding a glazing bar to a standard VELUX roof window with grey exterior. This will allow you to take advantage of all roof window styles and sizes available (except triple glazed roof windows).

**Grey glazing bars are also available for standard VELUX roof windows**

### Recessed flashing



As well as the addition of a glazing bar, your local conservation officer may request that your roof window be installed deeper into the roof than can be achieved with a standard installation. To do this you should select a recessed flashing kit, which will provide a sleek, streamlined finish as less of the roof window protrudes above the roofline. Recessed flashings are also available with insulation and underfelt collars and are recommended for optimum energy efficiency.

Our full range of recessed flashings are available as part of our conservation roof window packages and help you comply with local conservation requirements.

### To create your grey conservation package:

- Select your preferred VELUX roof window. This includes white painted, white polyurethane, pine and all operating methods (pages 20-25).
- Choose a flashing kit suitable for your specific roof pitch and roofing material – a recessed flashing kit is recommended (pages 50-51).
- Use VELUX installation products for optimum energy efficiency (pages 48-49).
- Add one or more conservation glazing bars in the corresponding size to your roof windows.

Grey glazing bar to match grey exterior (nearest RAL 7043) finish of standard VELUX roof windows.

We recommend the use of two glazing bars for our wider roof windows such as SK06, UK04 and UK08.

Optional glazing bars for standard windows	CK02	CK04	MK04	UK04	CK06	FK06	MK06	SK06	MK08	PK08	UK08	PK10
▶ 2 glazing bars for UK04, SK06 & UK08	ZGA WK02 0024 £20	ZGA WK04 0024 £22			ZGA WK06 0024 £24			ZGA WK08 0024 £26			ZGA WK10 0024 £28	

- ▶ Glazing bars are not available for –66 and –62 triple glazing variants.
- ▶ Prices above are for 1 glazing bar only.
- ▶ All glazing bars have a delivery time of 2 days.
- ▶ Delivery time is in working days from receipt of orders placed before 4pm (UK) and 3pm (NI).





## VELUX CABRIO® balcony

Transforms from a roof window into a balcony in seconds

Featured: VELUX CABRIO® balcony (GDL SK19 SKOW224)

### VELUX CABRIO® balcony



Roof pitch



The VELUX CABRIO® balcony transforms from a roof window into a balcony in seconds. This is a great way to add real wow factor to a property.

- The upper section is top-hung and opens outwards whilst the bottom section unfolds into a glazed balcony with side railings.
- Can be easily combined with additional top-hung and fixed sloping roof windows to increase the daylight and view.
- Made of high quality white painted natural pine.

- Double and triple units include EKY (100mm) support trimmers.
- Two sizes available providing you with more space to enjoy the outdoors, indoors.
- Featuring triple glazing as standard which contributes to an energy efficient installation.
- The pane has a toughened outer and a laminated inner pane for additional safety.

- Easy-to-clean coating on the toughened outer pane keeps the glazing cleaner for longer.
- Top-hung section rotates 180° and locks in to place for easy cleaning of the outer pane.
- Other combinations available – contact us for further information.
- VELUX blinds are available for this product see [veluxblindsdirect.co.uk](http://veluxblindsdirect.co.uk)

### VELUX CABRIO® balcony

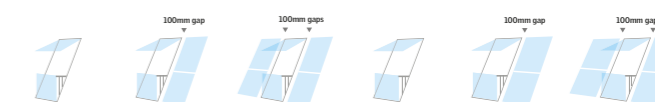

External frame size (nominal w x h) cm

Code	Description	PK19	PK19	PK19	SK19	SK19	SK19
		94 x 252	198 x 252	302 x 252	114 x 252	238 x 252	362 x 252
		PK19	PK19	PK19	SK19	SK19	SK19
Packages include: Single VELUX CABRIO® balcony white painted roof window with optional one or two side units (GPL top-hung and GIL fixed element), triple glazing with toughened outer pane with easy-to-clean and anti-dew* coating and laminated inner pane for additional safety, flashings and EKY support trimmer(s).							
GDL SD0L001	VELUX CABRIO® balcony + flashings for slate up to 8mm thick.	£2,014	-	-	£2,126	-	-
GDL SD0W001	VELUX CABRIO® balcony + flashings for tiles up to 120mm in profile.	£2,014	-	-	£2,126	-	-
GDL SKOL222	VELUX CABRIO® balcony + 1 x GPL & 1 x GIL. Flashings for slate up to 8mm thick.	-	£3,747	-	-	£4,012	-
GDL SKOW224	VELUX CABRIO® balcony + 1 x GPL & 1 x GIL. Flashings for tiles up to 120mm in profile.	-	£3,747	-	-	£4,012	-
GDL SKOL322	VELUX CABRIO® balcony + 2 x GPL & 2 x GIL. Flashings for slate up to 8mm thick.	-	-	£5,457	-	-	£5,870
GDL SKOW322	VELUX CABRIO® balcony + 2 x GPL & 2 x GIL. Flashings for tiles up to 120mm in profile.	-	-	£5,457	-	-	£5,870

- ▶ All roof windows have a delivery time of 7 days.
- ▶ Delivery time is in working days from receipt of orders placed before 4pm (UK) and 3pm (NI).

\*Anti-dew coating reduces number of hours external condensation is present.



## Sloping and vertical combinations

Expand your view



Roof pitch

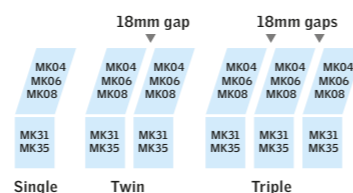

Combine sloping and vertical white painted or white polyurethane roof windows to expand your view and increase daylight. Ideal for one and a half storey properties.

Follow the steps to find the best solution for your room:

1. Decide on your combination – single, twin or triple.
2. Select your white painted or white polyurethane roof windows in size MK04, MK06 or MK08 (**prices not included**). Choose from:
  - Centre-pivot – see pages 20-21.
  - VELUX INTEGRA® – see pages 22-23.
  - Top-hung – see pages 24-25.
3. Select your bottom vertical element(s) – size MK31 or MK35. **The white painted vertical element is bottom-hung and opens inwards for added ventilation and cleaning. The white polyurethane element is fixed.**
4. Select the appropriate flashing system for your roof window size, combination and roofing material.
  - If selecting twin or triple combinations, we recommend the use of an EBY trimmer for added support and a harmonious internal finish.

Other combinations can be created – contact us for further information.

### Vertical elements

External frame size (nominal w x h) cm

Code	Glazing	MK31	MK35
<b>White polyurethane – Fixed</b>			
VIU 0070	Laminated inner, toughened outer pane.	£387	£420
VIU 0060	Laminated inner, toughened outer pane. Easy-to-clean coating, enhanced noise reduction.	£450	£480
VIU 0066	Triple glazed. Laminated inner, toughened outer pane. Anti-dew* and easy-to-clean coating.	£537	£570
<b>White painted – bottom-hung opening inwards</b>			
VFE 2070	Laminated inner, toughened outer pane.	£387	£420
VFE 2060	Laminated inner, toughened outer pane. Easy-to-clean coating, enhanced noise reduction.	£447	£480
VFE 2066	Triple glazed. Laminated inner, toughened outer pane. Anti-dew* and easy-to-clean coating.	£537	£570

\*Anti-dew coating reduces number of hours external condensation is present.

### Flashings

External frame size (nominal w x h) cm

Code	Description	MK04	MK06	MK08
EFL 0012	Single installation, for slate up to 8mm thick.	£111	£116	£124
EFW 0012	Single installation, for tiles up to 120mm in profile.	£111	£116	£124
EFL 0022B	Twin installation, for slate up to 8mm thick.	£221	£232	£248
EFW 0022B	Twin installation, for tiles up to 120mm in profile.	£221	£232	£248
EFL 0032B	Triple installation, for slate up to 8mm thick.	£332	£348	£372
EFW 0032B	Triple installation, for tiles up to 120mm in profile.	£332	£348	£372

### Internal trimmer – white

Code	Description			
EBY W10 2100	18mm gap adjustable trimmer (x1 for Twin installation, x2 for Triple installation). White painted.	-	-	£386

- ▶ All roof windows, single flashing and trimmers have a delivery time of 7 days except VFE 2060 windows, VFE 2066, and twin and triple flashings which are 16 days.
- ▶ Delivery time is in working days from receipt of orders placed before 4pm (UK) and 3pm (NI).

## Sloping and fixed combinations

Create light-filled rooms



Roof pitch



Multiple VELUX roof windows create gorgeous, light-filled rooms and the amazing feeling of being outside. By combining VELUX roof windows you can add a great panoramic view and more natural light to give your home its own unique character. If the pitch of your roof continues to the floor, you can extend your VELUX roof window by installing an additional window element, GIU (maintenance-free white polyurethane) or GIL (white painted) below. **These windows have a fixed sash that cannot be opened.**

Follow the steps below to find the best solution for your room:

1. Decide on your combination.
2. Select your opening roof window(s) in sizes MK04, MK06, MK08, PK08 and PK10. Choose from:
  - Centre-pivot – see pages 20-21.
  - VELUX INTEGRA® – see pages 22-23.
  - Top-hung – see pages 24-25.
3. Select your bottom fixed element(s) – sizes MK34 or PK34.
4. Select the appropriate flashing system for your roof window size and roofing material.

Other combinations can be created – contact us for further information.

- ▶ All roof windows and flashings have a delivery time of 7 days.
- ▶ Delivery time is in working days from receipt of orders placed before 4pm (UK) and 3pm (NI).

### Sloped additional elements

External frame size (nominal w x h) cm

Code	Glazing	MK34	PK34
<b>White polyurethane – Fixed</b>			
For a maintenance-free white polyurethane finish additional window elements GIU can be installed below VELUX roof windows GGU and GPU.			
GIU 0070	Laminated inner, toughened outer pane.	£414	£478
GIU 0060	Laminated inner, toughened outer pane. Easy-to-clean coating, enhanced noise reduction.	£474	£538
GIU 0066	Triple glazed. Laminated inner, toughened outer pane. Anti-dew* and easy-to-clean coating.	£564	£628
<b>White painted – Fixed</b>			
For a white painted combination additional window elements GIL can be installed below VELUX roof windows GGL and GPL.			
GIL 2070	Laminated inner, toughened outer pane.	£377	£431
GIL 2060	Laminated inner, toughened outer pane. Easy-to-clean coating, enhanced noise reduction.	£433	£491
GIL 2066	Triple glazed. Laminated inner, toughened outer pane. Anti-dew* and easy-to-clean coating.	£523	£581

\*Anti-dew coating reduces number of hours external condensation is present.

### Flashings – single

External frame size (nominal w x h) cm

Code	Description	MK04	MK06	MK08	PK08	PK10
EDL S0121	Single installation for slate up to 8mm thick.	£95	£98	£102	£109	£112
EDW S0121	Single installation for tiles up to 120mm in profile.	£95	£98	£102	£109	£112



Coming  
Spring  
2017

## VELUX curved glass rooflight



When ordering your curved glass rooflight please ensure you order a base unit (CFP or CVP) and compatible top cover.

## VELUX flat roof windows

Performs from every angle

Featured:  
VELUX curved glass rooflights  
(CVP 100100 0673QV and  
ISD 100100 1093)

### The premium choice

The VELUX curved glass rooflight is the premium choice for homeowners with 0-15° pitched roofs.

The curved glass top unit consists of 6mm scratch-free glazing with a glass-to-edge design that extends beyond the supporting frame, meaning a clear external pane is left for a better view.

Bordering the unit is a black underlying coating, which ensures a discreet visual connection to the roof. The innovative and unique design of the curved glass top cover provides optimal functionality, creates a simple and modern look inside and out and a clear view – featured as CurveTech.

The top cover is available in combination with an electrically vented or fixed rooflight element. The flat roof window consists of a high insulation, PVC-construction and an integrated 2-layer low-energy pane. The electrically vented option comes with VELUX INTEGRA® automated operation and an array of pre-set programmes for automatic ventilation and daylight control.

VELUX curved glass rooflight features excellent noise reduction in case of rain, hail or other exterior disturbances. Blinds are available for daylight control and an awning blind for heat protection.

- Elegant solution for externally visible installations.
- Glass-to-edge construction allows for a clear, uninterrupted view.
- Low maintenance due to curved glass providing natural drainage.
- 3-layer glass construction ensures optimal energy performance.
- 1.2 U-value energy pane for reduced energy consumption.
- Scratch-free glass prolongs the unit's expected life time.
- Hassle-free installation in 0-15° roof pitch.

For  
pricing see  
page 35



## VELUX flat glass rooflight

Elegant on the outside, hard-working on the inside



When ordering your flat glass rooflight please ensure you order a base unit (CFP or CVP) and compatible top cover.

VELUX flat glass rooflights are a stylish addition to our flat roof window range – featuring an attractive eye-catching glass pane, making it an alternative to the classic domed VELUX flat rooflight.

### Convenience and high performance

As well as an innovative design, the flat glass rooflight features all of the outstanding specifications you'd expect from VELUX.

- It requires minimum maintenance as it comprises a maintenance-free PVC framework and lacquered aluminium cladding.
- It is highly energy efficient. Our high-performance insulation is integrated into the frame to give the best possible protection against heat loss.
- Can be installed below 5° if an upstand is manufactured to raise the angle of rooflight to 5°.



### Fixed rooflight

The VELUX fixed flat glass rooflight can transform any space and is ideal where there is a need for bringing in a great deal of natural daylight without adding extra ventilation. The double glazed unit has a laminated inner pane for additional safety.



### Vented rooflight

The VELUX vented flat glass rooflight provides ventilation and fresh air through the roof, and it can be operated automatically with the VELUX INTEGRA® control pad.

## VELUX curved and flat glass rooflight

Options and pricing



When ordering your curved or flat glass rooflight please ensure you order a base unit (CFP or CVP) and compatible top cover.

### Curved and flat glass rooflight

External frame size including kerb (nominal w x h) cm	78 x 78	78 x 108	98 x 98	108 x 108	118 x 118	108 x 138	138 x 138	118 x 168	
Structural openings (nominal w x h) cm	60 x 60	60 x 90	80 x 80	90 x 90	100 x 100	90 x 120	120 x 120	100 x 150	
Code	Description	060060	060090	080080	090090	100100	090120	120120	100150
<b>Fixed</b>									
<b>CFP 0073QV</b> U-value 1.2 W/m²K	Fixed flat roof window base with double glazed insulating glass unit featuring laminated inner pane for safety.	£262	£280	£295	£339	£369	£391	£450	£472
<b>VELUX INTEGRA®</b>									
<b>CVP 0673QV</b> U-value 1.2 W/m²K	Electrically operated flat roof window base with double glazed insulating glass unit featuring laminated inner pane for safety.	£652	£670	£685	£729	£759	£781	£840	£862
<b>Top cover</b>									
<b>ISD 1093</b>	Curved glass top cover.	£349	£374	£394	£453	£492	£522	£600	£630
<b>ISD 2093</b>	Flat glass top cover.	£286	£307	£323	£371	£403	£428	£492	£516
<b>Accessories</b>									
<b>ZCE 0015</b>	Extension kerb 150mm. Also compatible with CXP.	£140	£147	£150	£165	£179	£183	£202	£204
<b>ZZZ 210</b>	Frame fixing kit for roof material. Also compatible with CXP.	£32	£34	£35	£38	£41	£42	£47	£47

- ▶ All roof windows have a delivery time of 2 days.
- ▶ Delivery time is in working days from receipt of orders placed before 4pm (UK) and 3pm (NI).



## VELUX flat roof domes

Transform and improve flat roof areas

- Double-glazed roof window with protective polycarbonate cover.
- Excellent sound insulation from rain and hail.
- Available fixed (without background ventilation) or VELUX INTEGRA® electrically operated with hidden motor, rain sensor and control pad or manually operated.
- Certified to European Security Standards EN 1627-30.
- Energy efficient with an interior area Uw-value of 1.4W/m²K (certified to EN 12567-2) and an external surface area Ud-value of 0.72W/m²K.
- Clear or obscure polycarbonate cover.
- Available in 9 sizes with kerb height of 150mm.
- AA fire rated.
- 150mm extension kerb allows installation in warm or sedum roof constructions.



Roof pitch



When ordering your flat roof window please ensure you order a base unit (CFP, CVP or CXP) and compatible top cover

**FLAT ROOF BLINDS**  
Find these products in this brochure: FMG, FSK and FMK p59 & MSG p61

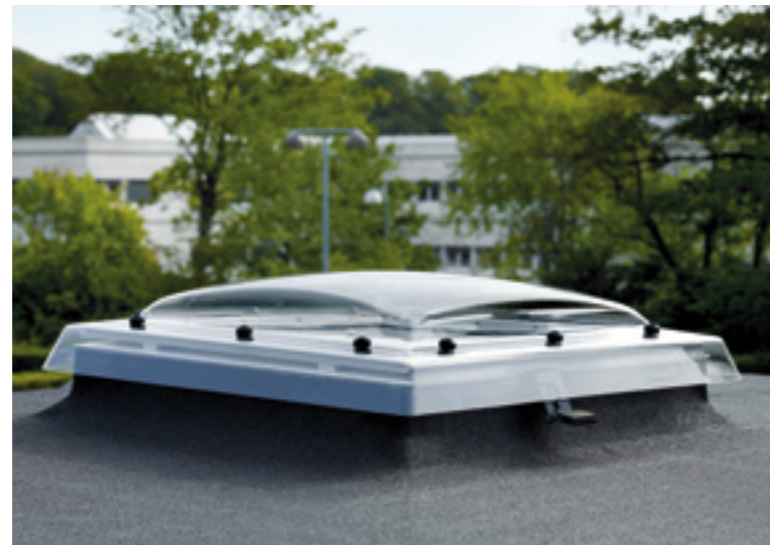

## VELUX flat roof domes

Access and emergency escape



Roof pitch



- Manually operated flat roof exit solution.
- Double-glazed roof window with polycarbonate cover.
- Opening angle of approximately 60°.
- Available in three sizes – 100100, 090120 and 120120.
- Clear or obscure polycarbonate cover.
- Excellent insulating value and sound reduction.
- Note: this product is not compatible with VELUX flat roof blinds FMG, FSK, FMK and MSG.

## VELUX flat roof domes

Options and pricing

Flat roof domes

Code	Description	060060	060090	080080	090090	100100	090120	120120	100150	150150
<b>Fixed</b>										
<b>CFP 0073QV</b> U-value 1.2 W/m²K	Fixed flat roof window base with double glazed insulating glass unit featuring laminated inner pane for safety.	£262	£280	£295	£339	£369	£391	£450	£472	£594
<b>VELUX INTEGRA®</b>										
<b>CVP 0673QV</b> U-value 1.2 W/m²K	Electrically operated flat roof window base with double glazed insulating glass unit featuring laminated inner pane for safety.	£652	£670	£685	£729	£759	£781	£840	£862	£984
<b>Access and emergency escape</b>										
<b>CXP 0473Q</b> U-value 1.5 W/m²K	Manually operated flat roof window base for access or escape with double glazed insulating glass unit featuring laminated inner pane for safety. Compatible with polycarbonate dome top covers only.	-	-	-	-	£738	£782	£900	-	-
<b>Top cover</b>										
<b>ISD 0010A</b>	Clear polycarbonate dome.	£175	£187	£197	£226	£246	£261	£300	£315	£396
<b>ISD 0110A</b>	Obscure polycarbonate dome.	£175	£187	£197	£226	£246	£261	£300	£315	£396
<b>Accessories</b>										
<b>ZCE 0015</b>	Extension kerb 150mm.	£140	£147	£150	£165	£179	£183	£202	£204	£236
<b>ZZZ 210</b>	Frame fixing kit for roof material.	£32	£34	£35	£38	£41	£42	£47	£47	£54

- ▶ All roof windows have a delivery time of 2 days.
- ▶ Delivery time is in working days from receipt of orders placed before 4pm (UK) and 3pm (NI).

## VELUX flat roof kerb

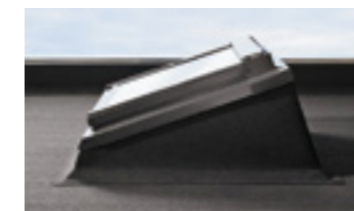

Flat roof kerb

All the benefits of a VELUX roof window in a flat roof.

- Insulated timber kerb to allow the installation of a standard VELUX roof window into a flat roof.
- Select the insulated timber kerb to match the size of your roof window.
- Allows you the flexibility to select the most appropriate type of roof window for your application such as white polyurethane finish or VELUX INTEGRA®.
- Roofing material is dressed up the sides of the kerb, then overlapped with the aluminium cover parts.
- Refer to pages 20-23 for info on roof windows.
- **Roof window not included.**

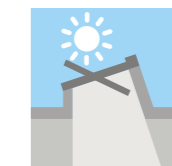
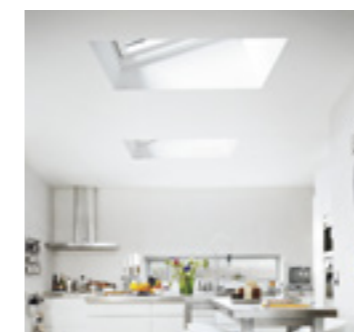

Roof pitch



Flat roof kerb

Code	Description	CK02	CK04	MK04	MK06	MK08	SK06	UK08
<b>ECX 0000T</b> U-value 0.6 W/m²K	Insulated timber kerb for installation of VELUX roof window into flat roof (kerb only).	£239	£245	£275	£289	£332	£341	£391

- ▶ All roof windows and flat roof kerbs have a delivery time of 2 days.
- ▶ Delivery time is in working days from receipt of orders placed before 4pm (UK) and 3pm (NI).



## VELUX Modular Skylights

Open up larger roof expanses



Roof pitch



VELUX INTEGRA® control pad with touch screen and swipe function uses icons for easy and intuitive control.



For further inspiration visit [velux.co.uk/vmsdomestic](http://velux.co.uk/vmsdomestic)

### Why VELUX Modular Skylights?

VELUX Modular Skylights are specially designed to bring more natural light into modern, flat roof homes and extensions. Modularity allows you to design with daylight over larger roof expanses, with an end result that blends more with the surroundings.

### Unique design

Developed in collaboration with renowned architects Foster + Partners, VELUX Modular Skylights offer a slim profile design which is great for modern homes that need to make most of the daylight. Electrics and motors within vented modules are concealed, creating a simple and refined look, inside and out.



### Light up the rooms in your home

The kitchen is the heart of the home, and the range of activities we enjoy there means that the lighting must meet everyone's needs – whilst also keeping the room looking good, morning, noon and night.

With VELUX Modular Skylights, the light enters directly from above, right into the centre of your room. This is a much stronger source of illumination than limited light coming from your vertical windows.



## VELUX Modular Skylights

Open up your home to more natural light

Featured: VELUX Modular Skylights (5 x longlight modules, comprising 3 x fixed and 2 x vented).



## VELUX sun tunnels

### Natural daylight solutions

Natural daylight where you never thought it could be achieved. Ideal for windowless bathrooms, hallways and cupboards. Our sun tunnels feature a number of innovative features that improve performance and make installation even simpler than before.

- Easy to install with integral flashing.
- Double layer diffuser with new Edge-Glow technology increases the spread of light internally.
- Can be used for night time lighting with an optional low energy light kit.
- Ventilation outlet allows connection of an extractor fan and duct (supplied by others) available for TWR OK14 and TWF OK14 sun tunnels. Contact us for further information.

### Choosing your sun tunnel

- We recommend rigid sun tunnels for maximum light.
- Recommended tunnel length for a rigid sun tunnel is 0.9-6.0m.
- 1.7m supplied as standard. Additional length can be made up with ZTR extension kits.
- Recommended tunnel length for flexible sun tunnel 0.4m-1.5m (pitched roof) and 0.2-0.9m (flat roof) in cases where an obstacle may prevent the use of a rigid tunnel.

### Pitched roof sun tunnels

- Rigid (10" or 14") or flexible (14") tunnels.
- Exterior flat glass window appearance.
- Easy-to-clean coating keeps glass cleaner for longer.

### Flat roof sun tunnels

- Available in 14" flexible tunnels.
- White PVC kerb with clear polycarbonate dome.

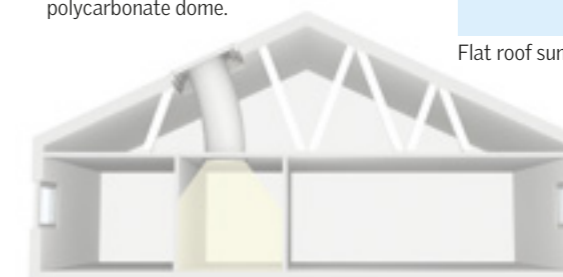

### Roof pitch



Pitched roof sun tunnel

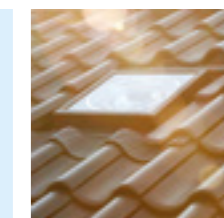

A discreet external finish which matches our other roof window products.



Flat roof sun tunnel

A sun tunnel lets natural light into the smallest, darkest internal corridors and cupboards.

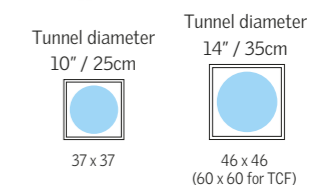

### Sun tunnels

#### External frame size (nominal w x h) cm

Code	Description	10"	14"
<b>Rigid sun tunnels</b>			
TWR OK10 2010	10" diameter rigid tunnel for tiles up to 120mm in profile.	£265	-
TLR OK10 2010	10" diameter rigid tunnel for slate up to 8mm thick.	£265	-
TWR OK14 2010	14" diameter rigid tunnel for tiles up to 120mm in profile.	-	£305
TLR OK14 2010	14" diameter rigid tunnel for slate up to 8mm thick.	-	£305
<b>Flexible sun tunnels</b>			
TWF OK14 2010	14" diameter flexible tunnel for tiles up to 120mm in profile.	-	£265
TLF OK14 2010	14" diameter flexible tunnel for slate up to 8mm thick.	-	£265
<b>Flat roof sun tunnels</b>			
TCF OK14 1010	14" diameter flat roof flexible tunnel with polycarbonate cover.	-	£320
<b>Accessories</b>			
ZTR OK10 0062	600mm extension section for 10" rigid diameter sun tunnel.	£57	-
ZTR OK14 0062	600mm extension section for 14" rigid diameter sun tunnel.	-	£57
ZTR OK14 0124	1,200mm extension section for 14" rigid diameter sun tunnel.	-	£110
ZTL 014	Low-energy light kit for 10" and 14", fits inside tunnel, requires mains connection. Bulb supplied.	-	£73

- ▶ All sun tunnels and accessories have a delivery time of 2 days.
- ▶ Delivery time is in working days from receipt of orders placed before 4pm (UK) and 3pm (NI).

VELUX sun tunnels  
Natural daylight for windowless areas

Featured: VELUX sun tunnels (TWR OK14 2010)



## Smoke ventilation system

For situations where smoke ventilation is required



### Roof pitch



Available for 1m<sup>2</sup> (SK06 size) or 1.5m<sup>2</sup> (UK08 size) of smoke-free ventilation area.

- Maintenance free, centre-pivot, white polyurethane roof window.
- For geometric smoke ventilation our systems are tested and certified to EN ISO 12101-2 for roof pitches between 15-90°.
- For aerodynamic smoke ventilation our systems are tested and certified to EN ISO 12101-2 for roof pitches between 15-60°.
- Comes with laminated inner pane for additional safety.
- System can be upgraded to comply with aerodynamic smoke ventilation requirements by the inclusion of the optional KFD external wind deflector.
- Other sizes available, contact us for further information.

### Smoke ventilation system

External frame size (nominal w x h) cm

114 x 118 134 x 140

Code	Description	SK06	UK08
Packages include: Single electrically operated GGU white polyurethane roof window with laminated inner pane for additional safety, 1 smoke sensor, 1 break glass point, 1 wall control (KFC 210) and suitable flashing. Additional smoke sensors and break glass units can be purchased separately.			
GGU SD0L140 U-value 1.3 W/m <sup>2</sup> K	GGU 0070 roof window + flashings for slate up to 8mm thick.	£1,543	£1,631
GGU SD0W140 U-value 1.3 W/m <sup>2</sup> K	GGU 0070 roof window + flashings for tiles up to 120mm in profile.	£1,543	£1,631
KFD 0000	Wind deflector (for compliance to aerodynamic smoke ventilation requirements).	£458	£516

- ▶ All roof windows have a delivery time of 2 days except KFD 0000 which are 7 days.
- ▶ Delivery time is in working days from receipt of orders placed before 4pm (UK) and 3pm (NI).



### Roof pitch



When ordering your flat roof window please ensure you order a base unit (CSP) and compatible dome

### Flat roof smoke ventilation

External frame size (nominal w x h) cm

118 x 118 138 x 138

Structural opening size (nominal w x h) cm

100 x 100 120 x 120

Code	Description	100100	120120
CSP 1073Q	Smoke vent base. Compatible with polycarbonate dome top covers only.	£1,476	£1,801
ISD 0010A	Clear polycarbonate dome.	£246	£300
ISD 0110A	Obscure polycarbonate dome.	£246	£300
Accessories			
KFC 210	Control system for operation of 4 pitched roof windows or 1 flat roof window.	-	£570
KFC 220	Control system for operation of 8 pitched roof windows or 2 flat roof windows.	-	£738
KFA 100	Smoke sensor.	-	£70
KFK 100	Break glass unit.	-	£70

- ▶ All roof windows have a delivery time of 2 days.
- ▶ Delivery time is in working days from receipt of orders placed before 4pm (UK) and 3pm (NI).

### Flat roof smoke ventilation system

Innovative solution for a flat roof where smoke ventilation is required. Available for 0.88m<sup>2</sup> (100x100cm) or 1.30m<sup>2</sup> (120x120cm) of smoke-free ventilation area.

- Double-glazed window with protective polycarbonate cover.
- AA fire rated.
- Tested and certified to EN ISO 12101-2.
- Smoke sensors, control systems and break glass units to be purchased separately.

## Rooflights for uninhabited spaces

Bring in more daylight



### Roof pitch



### Rooflights

- Frame and integrated flashing made of maintenance-free polyurethane.
- Operated using a handle with three ventilation positions.
- Extruded aluminium sash which can be hinged on both sides, opening to an angle of 90°.
- Opening restrictor which engages at 90° only.
- Black internal and external finish.



### Uninhabited spaces

Our rooflights are designed in such a way that you have the opportunity to bring light into uninhabited spaces. It is not advisable to use these rooflights in habitable rooms because of their thermal performance.

### Rooflights for uninhabited spaces

External frame size (nominal w x h) cm

54 x 83 46 x 61

Code	Description	54 x 83	46 x 61
GVT 103 0059Z U-value 3.1 W/m <sup>2</sup> K	Side-hung outward-opening rooflight.	£188	-
GVK 0000Z U-value 5.1 W/m <sup>2</sup> K	Side-hung outward-opening rooflight.	-	£138

- ▶ All rooflights have a delivery time of 7 days.
- ▶ Delivery time is in working days from receipt of orders placed before 4pm (UK) and 3pm (NI).



## Replacing existing roof windows

It's time for a change. Let in more daylight, create more comfort and increase energy efficiency.

### Think bigger

Replacing a roof window is the perfect opportunity to bring even more light in. You'd be surprised how much brighter a room can become if you make the roof window even slightly bigger. Or that by adding a second roof window to the one you are replacing, you get twice the daylight.

We have provided the same range of roof window sizes for the last 40 years, so it is usually very easy to find a direct size match.

- Minimal disruption as roof windows are replaced in the existing aperture.
- Replacement installation can typically be carried out in a day.
- Work can be carried out from the inside – no need for external scaffolding.

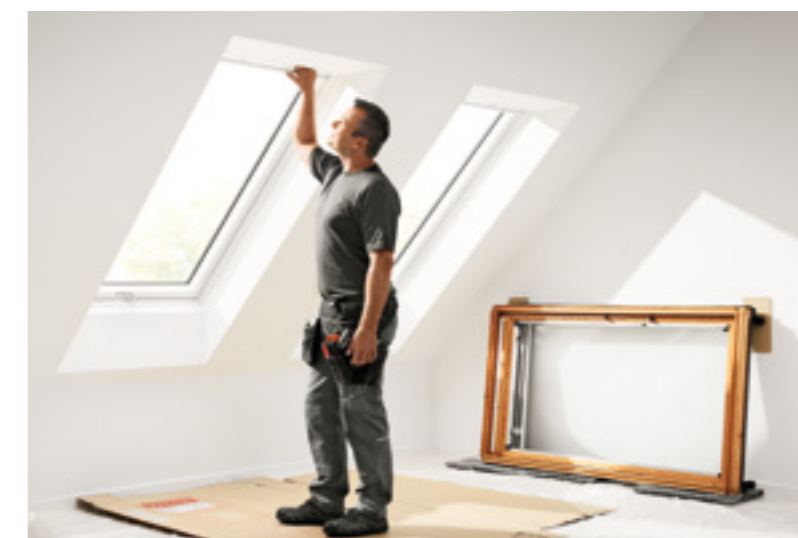

### Always improving

We continuously work towards improving our products and energy efficiency.

- Improved thermal performance and sound reduction for greater comfort.
- More attractive design and better integration into the roof.
- Larger glazing areas allowing more daylight in.
- Improved air tightness and insulation around the roof window due to insulation collar.
- Upgrade to a white finish or VELUX INTEGRA® solar or electric remote operation.
- **VELUX INTEGRA® solar powered roof windows** are ideal for replacing older roof windows as no wiring is required.

### Save time and money with VELUX replacement flashings

EL and EW single replacement flashings are essential for replacing older VELUX roof windows manufactured before April 2001 with a current roof window while maintaining the original installation level of the roof window.

This allows old roof windows to be replaced without disturbing the interior finish of the room, saving you a lot of work. If you were to use a standard flashing you would need to re-do the internal lining around the roof window.

We recommend the use of EL and EW flashings for all replacement projects – only if you intend to alter the ceiling around the roof window should you consider using a standard flashing kit instead.

## Replacing existing roof windows

Replacing your roof windows is quick and straightforward

Featured: VELUX centre-pivot white painted roof windows (GGL PK10 2070)

### Replacement roof window flashings

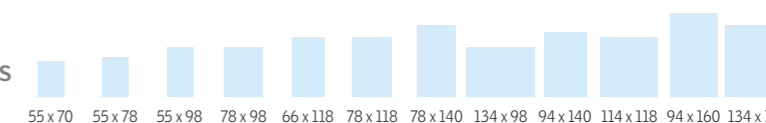

Code	Description	CK01	CK02	CK04	MK04	FK06	MK06	MK08	UK04	PK08	SK06	PK10	UK08
<b>For replacing single roof windows installed before April 2001. (Window size to be replaced shown in brackets.)</b>		(101)	(102)	(104)	(304)	(206)	(306)	(308)	(804)	(408)	(606)	(410)	(808)
		(9)		(6)	(1)		(14)	(2)	(7)		(4)	(3)	(8)
<b>EL 6000</b>	For slate up to 8mm thick. Includes insulation collar.	£86	£87	£89	£99	£99	£103	£110	£125	£119	£120	£124	£134
<b>EW 6000</b>	For tiles up to 120mm thick. Includes insulation collar.	£86	£87	£89	£99	£99	£103	£110	£125	£119	£120	£124	£134
<b>ELX 0000</b>	Adaptor flashing for combinations. Also for use in conjunction with EDL & EDV.	£70	£70	£72	£81	£81	£85	£91	£107	£101	£100	£104	£115

- ▶ All replacement flashings have a delivery time of 7 days.
- ▶ Delivery time is in working days from receipt of orders placed before 4pm (UK) and 3pm (NI).



## Upgrading existing roof windows

Improve the functionality of existing roof windows with automated solar and electric operation.



8 pre-defined programs on the VELUX INTEGRA® control pad:

- Indoor climate
- Ventilation
- Energy balance
- Sun screening
- Good night
- Good morning
- Leaving home
- On vacation

Upgrade manual roof windows to VELUX INTEGRA® solar or electric powered operation.

Ideal for out-of-reach situations.

### Opening operation

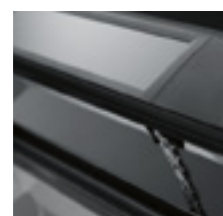

#### SOLAR POWERED

- All the same features as VELUX INTEGRA® electric roof windows, but powered by the sun.
- PV solar cell on external window frame requires direct exposure to sunlight.
- No need to plug into a power supply, making installation even quicker, easier and no need for redecoration.



#### ELECTRIC

- Fully programmable control pad can operate roof windows, blinds, awnings and roller shutters individually or in groups.
- Easy to order and install – just plug into power supply.
- Control pad operation can be used within 20m of the roof windows.
- Fully integrated motor which runs almost without a sound.
- Added comfort and ventilation in areas that have been previously out-of-reach.

Code	Description	Price
KSX 100	Conversion kit to upgrade to full VELUX INTEGRA® solar powered functionality of GGU or GGL centre-pivot roof windows manufactured between April 1986 and January 2014 (includes rain sensor). Not compatible with M27, P25 and 425.	£350
KSX 100K	Conversion kit to upgrade to full VELUX INTEGRA® solar powered functionality of GGU or GGL centre-pivot roof windows manufactured after February 2014 (includes rain sensor). Not compatible with CK01, CK02, MK27, PK25 and SK01.	£400
KMX 110	Electric conversion kit to upgrade to full VELUX INTEGRA® functionality of GGU or GGL centre-pivot roof windows manufactured between April 1986 and January 2014 (includes rain sensor). Not compatible with M27, P25 and 425.	£328
KMX 110K	Electric conversion kit to upgrade to full VELUX INTEGRA® functionality of GGU or GGL centre-pivot roof windows manufactured after February 2014 (includes rain sensor). Not compatible with CK01, CK02, MK27, PK25 and SK01.	£328
KLR 200	VELUX INTEGRA® control pad for use with VELUX INTEGRA® roof windows manufactured after 2005.	£120

▶ All conversion kits have a delivery time of 2 days. KLR 200 has a delivery time of 2 days. All replacement roof window panes have a delivery time of 7 days.

## Upgrading glazing

Advances in pane technology allow the upgrading of existing glazing units to provide better heat and sound insulation properties. All panes are AA fire rated.



Turn your dream of a nice, peaceful sleep into a reality, reduce traffic noise in your home, minimise the sound of rain or hail on your roof window and increase energy efficiency simply with an upgrade to your glazing.

For roof windows manufactured before April 2001

Code	Glazing	9	102	6	104	5	304	206	306	308	804	606	410	808
(For roof windows, size of pane to be replaced is shown in brackets)		(9)	(102)	(6)	(104)	(5)	(304)	(206)	(306)	(308)	(804)	(606)	(410)	(808)
IPL 0059C	Toughened outer pane.	£64	£69	£70	£70	£84	£78	£84	£90	£98	£114	£115	£140	£176

▶ Looking to upgrade to a higher performing pane, contact our customer service support team.

For roof windows manufactured after April 2001

Code	Glazing	C02	C04	C06	M04	F06	M06	M08	U04	P08	S06	P10	U08
IPL 0034	Obscure laminated inner, toughened outer pane.	£91	£93	£99	£103	£111	£119	£130	£150	£183	£152	£185	£233
IPL 0073	Laminated inner, toughened outer pane.	£69	£70	£75	£78	£84	£90	£98	£114	£139	£115	£140	£176
IPL 0060	Laminated inner, toughened outer pane. Easy-to-clean coating, enhanced noise reduction.	£115	£118	£126	£131	£142	£152	£165	£191	£233	£194	£236	£296

For roof windows manufactured after February 2014

Code	Glazing	CK02	CK04	CK06	MK04	FK06	MK06	MK08	UK04	PK08	SK06	PK10	UK08
IPL 0034	Obscure laminated inner, toughened outer pane.	£91	£93	£99	£103	£111	£119	£130	£150	£183	£152	£185	£233
IPL 0070	Laminated inner, toughened outer pane.	£69	£70	£75	£78	£84	£90	£98	£114	£139	£115	£140	£176
IPL 0060	Laminated inner, toughened outer pane. Easy-to-clean coating, enhanced noise reduction.	£115	£118	£126	£131	£142	£152	£165	£191	£233	£194	£236	£296

▶ Delivery time is in working days from receipt of orders placed before 4pm (UK) and 3pm (NI).



## Installation products

Building regulations relating to insulation and air-tightness of roof window installations have become more stringent. We have not only developed a range of installation products to help make it quick and easy for you to be compliant, but the range also offers increased energy efficiency and a safe installation.

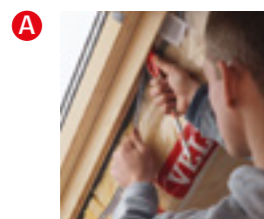

A

### Vapour barrier – BBX

- Helps prevent condensation from forming in the roof construction.
- Complete vapour barrier collar, fully welded in all corners.
- A fully welded rubber gasket with a double pressure seal guarantees speedy installation and a vapour and air tight solution.
- Reinforced corners for extra security against perforation.
- VELUX installation tool helps fit the collar in a matter of minutes.



B

### Insulation collar – BDX

- Insulates around the roof window frame, reducing heat loss and eliminating cold bridges.
- Makes insulating and installing the roof window a simple process.
- Supplied with BFX.
- Made to all standard roof window sizes.
- Click fittings ensure fast and accurate assembly.

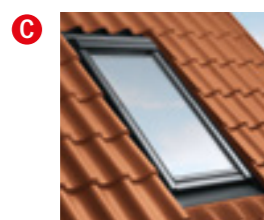

C

### Roof window

- The performance of your selected VELUX roof window is optimised by the use of installation products.
- All VELUX roof windows are compatible with VELUX installation products.
- Simply select your desired size, style and glazing option.

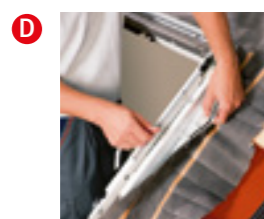

D

### Underfelt collar – BFX

- Ensures a weather-tight seal between the roof window and the roof.
- Can also be purchased separately from the insulation collar (BDX).
- Pleated material ensures a flexible and tight seal to the underfelt of the roof, whatever its construction.
- Made from diffusion open material to minimise risk of condensation.
- Comes with transverse drainage gutter to lead water away from the head of the roof window if a tile or slate is broken above the window.
- Welded corners ensure a watertight and simple installation.

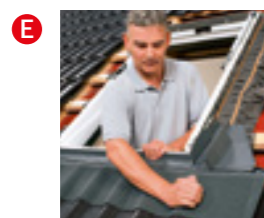

E

### Flashing

- Marries the roof window to the roofing material and ensures a weather-tight seal.
- Standard VELUX flashings are compatible with VELUX installation products.

## Installation products

External frame size (nominal w x h) cm		55 x 78	55 x 98	55 x 118	78 x 98	66 x 118	78 x 118	78 x 140	134 x 98	94 x 140	114 x 118	94 x 160	134 x 140
Code	Description	CK02	CK04	CK06	MK04	FK06	MK06	MK08	UK04	PK08	SK06	PK10	UK08
<b>BBX 0000</b>	Vapour barrier.	£22	£23	£24	£24	£24	£25	£27	£28	£28	£28	£29	£30
<b>BDX 2000</b>	Insulation collar for EDL / EDP / EDW (also includes BFX underfelt collar).	£30	£31	£33	£34	£34	£35	£37	£39	£38	£39	£40	£42
<b>BDX 2011</b>	Insulation collar for EBL / EBW / EBP twin installations (18mm gap).	£61	£63	£65	£68	£68	£71	£74	£78	£77	£78	£80	£84
<b>BDX 2011E</b>	Insulation collar for EKL / EKW and EKP coupled installations (100mm gap).	£61	£63	£65	£68	£68	£71	£74	£78	£77	£78	£80	£84
<b>BFX 1000</b>	Underfelt collar and transverse drainage gutter.	£21	£22	£23	£23	£23	£24	£26	£27	£27	£27	£28	£29

- ▶ All installation products have a delivery time of 2 days.
- ▶ Delivery time is in working days from receipt of orders placed before 4pm (UK) and 3pm (NI).

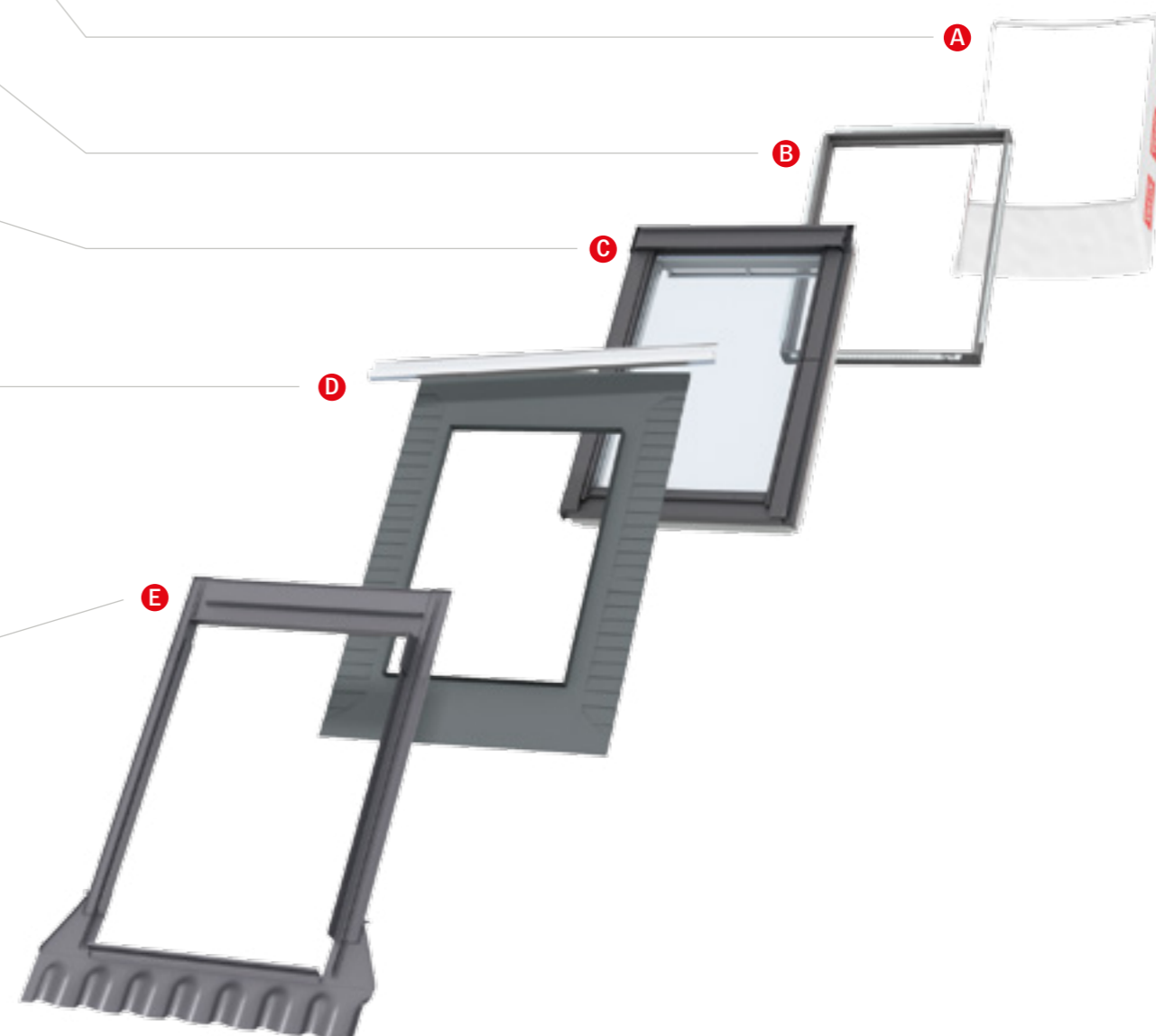

For use of installation products with recessed flashings, see packages on page 51.



## Flashings

We provide a range of flashing options to suit your roofing material. The information below will help you to select the most appropriate flashings for your installation.



This image is for illustration purposes only. Colour not a true representation.

### Compatibility

To find out more about the compatibility of roofing materials and flashings, and to learn more about different installations (such as thatch and interlocking slate tile), please go to [velux.co.uk/flashings](http://velux.co.uk/flashings)

Opening sizes depend on the flashings used. Instructions available online.

#### EDL / EBL / EKL



- Flashings for installing roof windows into slate up to 8mm thick.
- Not for interlocking slate. See below for EDW.

#### EDJ / EKJ



- Recessed flashings for installing roof windows into flat or profiled roofing material up to 90mm in profile.
- EDJ 2000 Includes BDX 2000F insulation package as standard.

#### EDN / EKN



- Recessed flashings for installing roof windows into slate up to 8mm thick.
- EDN 2000 Includes BDX 2000F insulation package as standard.
- Not for interlocking slate.

#### EDW / EBW / EKW



- Flashings for installing roof windows into flat or profiled roofing material up to 120mm in profile.
- Also for interlocking slate, thatch and profiled sheeting.
- Our EDW flashing suits virtually every installation and supersedes EDZ as our standard tile flashing.

#### EDP / EBP / EKP

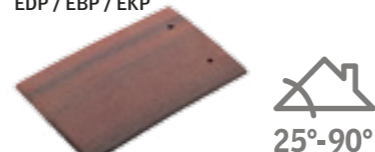

- Flashings for installing roof windows into plain tiles (max length 300mm).
- Maximum thickness of 14mm.

EDN, EDJ, EDL and EDW 2000 variants come with installation products included

## Recessed and standard flashings



Featured: EDJ recessed tile installation.



Featured: EDW standard tile installation.

### Recessed flashings

Recessed flashings provide a sleek and streamlined finish as the roof window is installed deeper into the roof structure (see image above), meaning that less of the roof window protrudes above the roofline. We recommend BDX insulation collar and BFX underfelt collar, included in EDN and EDJ 2000, for optimum energy efficiency.

Recessed installation height – install the brackets at the sides of the roof window frame, at the blue line level.

### Standard roof window flashings

We provide a range of flashing options to suit your roofing material. The table below will help you to select the most appropriate flashings.

Standard installation height – install the brackets at the top and the bottom of the window frame, at the red line level.

#### Recessed flashings

External frame size (nominal w x h) cm	55 x 78	55 x 98	55 x 118	78 x 98	66 x 118	78 x 118	78 x 140	134 x 98	94 x 140	114 x 118	94 x 160	134 x 140	
<b>Code</b>	CK02	CK04	CK06	MK04	FK06	MK06	MK08	UK04	PK08	SK06	PK10	UK08	
<b>Recessed flashings including installation products (BDX 2000F)</b>													
<b>EDN 2000</b>	For recessed installation in slate up to 8mm thick. Roof pitch 20°-90°.	£106	£110	£120	£122	£122	£127	£135	£152	£147	£146	£152	£164
<b>EDJ 2000</b>	For recessed installation in tiles up to 90mm in profile. Roof pitch 20°-90°.	£106	£110	£120	£122	£122	£127	£135	£152	£147	£146	£152	£164
<b>Recessed flashings not including installation products</b>													
<b>EDN 0000</b>	For recessed installation in slate up to 8mm thick. Roof pitch 20°-90°.	£67	£69	£72	£78	£78	£81	£87	£102	£97	£96	£100	£110
<b>EDJ 0000</b>	For recessed installation in tiles up to 90mm in profile. Roof pitch 20°-90°.	£67	£69	£72	£78	£78	£81	£87	£102	£97	£96	£100	£110

#### Single roof window flashings including installation products

Code	Description	CK02	CK04	CK06	MK04	FK06	MK06	MK08	UK04	PK08	SK06	PK10	UK08
<b>Standard flashings including installation products (BDX 2000)</b>													
<b>EDL 2000</b>	For slate up to 8mm thick. Roof pitch 15°-90°.	£76	£78	£82	£86	£86	£90	£96	£108	£104	£105	£108	£117
<b>EDW 2000</b>	For tiles up to 120mm in profile. Roof pitch 15°-90°.	£76	£78	£82	£86	£86	£90	£96	£108	£104	£105	£108	£117
<b>Standard flashings not including installation products</b>													
<b>EDL 0000</b>	For slate up to 8mm thick. Roof pitch 15°-90°.	£50	£51	£53	£57	£57	£60	£64	£75	£71	£71	£74	£81
<b>EDW 0000</b>	For tiles up to 120mm in profile. Roof pitch 15°-90°.	£50	£51	£53	£57	£57	£60	£64	£75	£71	£71	£74	£81
<b>EDP 0000</b>	For plain tiles up to 14mm thick. Roof pitch 25°-90°.	£50	£51	£53	£57	£57	£60	£64	£75	£71	£71	£74	£81

- ▶ All flashings have a delivery time of 2 days.
- ▶ Delivery time is in working days from receipt of orders placed before 4pm (UK) and 3pm (NI).
- ▶ Flashing colour NCS: S 7500-N. (Nearest RAL: 7043.) Flashings also available in titanium zinc, copper and a wide range of colours to match the roof window finish. See twin and combination flashings on pages 52-53.

## Twin and combination flashings

Opening sizes depend on the flashings used. Instructions available online.

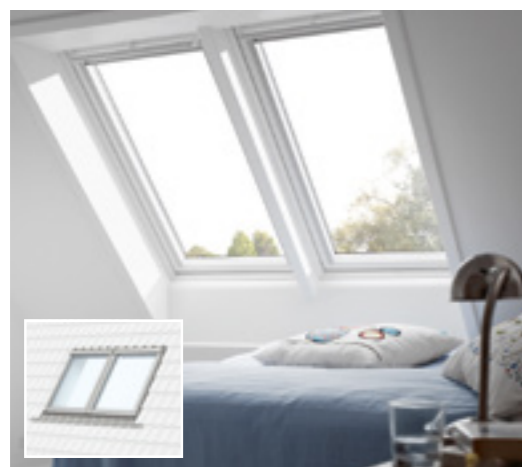

TWIN 18MM GAP



COUPLED 100MM GAP

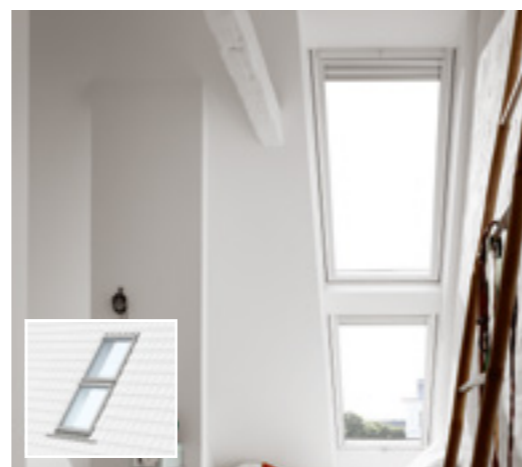

DUO 100MM GAP



TRIPLE 100MM GAP



QUATTRO 100MM GAP

### Twin and combination flashings

External frame size (nominal w x h) cm

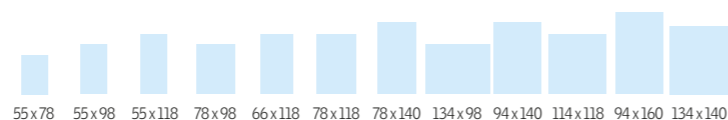

Code	Description	CK02	CK04	CK06	MK04	FK06	MK06	MK08	UK04	PK08	SK06	PK10	UK08
<b>EKN S0021E Coupled Recessed</b>	Side by side with 100mm gap for slate up to 8mm thick.	£186	£190	£200	£214	£214	£226	£240	£282	£268	£266	£276	£304
<b>EKJ S0021E Coupled Recessed</b>	Side by side with 100mm gap for tiles with max. profile 90mm.	£186	£190	£200	£214	£214	£226	£240	£282	£268	£266	£276	£304
<b>EBL 0021B Twin</b>	Side by side with 18mm gap for slate up to 8mm thick.	£124	£127	£133	£143	£143	£150	£160	£188	£178	£177	£184	£202
<b>EBW 0021B Twin</b>	Side by side with 18mm gap for tiles with a max. profile 120mm.	£124	£127	£133	£143	£143	£150	£160	£188	£178	£177	£184	£202
<b>EBP 0021B Twin</b>	Side by side with 18mm gap for plain tiles up to 14mm thick.	£124	£127	£133	£143	£143	£150	£160	£188	£178	£177	£184	£202
<b>EBL 0021C Twin</b>	Side by side with 50mm gap for slate up to 8mm thick.	£124	£127	£133	-	-	-	-	-	-	-	-	-
<b>EBW 0021C Twin</b>	Side by side with 50mm gap for tiles with a max. profile 120mm.	£124	£127	£133	-	-	-	-	-	-	-	-	-
<b>EKL 0021E Coupled</b>	Side by side with 100mm gap for slate up to 8mm thick.	£121	£124	£129	£139	£139	£146	£156	£184	£174	£172	£179	£197
<b>EKW 0021E Coupled</b>	Side by side with 100mm gap for tiles with a max. profile 120mm.	£121	£124	£129	£139	£139	£146	£156	£184	£174	£172	£179	£197
<b>EKP 0021E Coupled</b>	Side by side with 100mm gap for plain tiles up to 14mm thick.	£121	£124	£129	£139	£139	£146	£156	£184	£174	£172	£179	£197
<b>EKL S0122 Duo</b>	Above/below with 100mm gap for slate up to 8mm thick.	£129	£131	£137	£147	£147	£155	£165	£194	£184	£183	£191	£209
<b>EKW S0122 Duo</b>	Above/below with 100mm gap for tiles with a max. profile 120mm.	£129	£131	£137	£147	£147	£155	£165	£194	£184	£183	£191	£209
<b>EKL S0312 Triple</b>	Side by side with 100mm gap for slate up to 8mm thick.	£181	£186	£194	£209	£209	£219	£234	£276	£261	£258	£269	£296
<b>EKW S0312 Triple</b>	Side by side with 100mm gap for tiles with a max. profile 120mm.	£181	£186	£194	£209	£209	£219	£234	£276	£261	£258	£269	£296
<b>EKL S0222 Quatro</b>	Group of 4 with 100mm gap for slate up to 8mm thick.	£279	£284	£297	£319	£319	£336	£358	£422	£400	£396	£413	£453
<b>EKW S0222 Quatro</b>	Group of 4 with 100mm gap for tiles with a max. profile 120mm.	£279	£284	£297	£319	£319	£336	£358	£422	£400	£396	£413	£453

- ▶ Delivery time for all coupled flashings is 2 days except coupled recessed flashings which are 7 days. All other flashings have a delivery time of 7 days except EBP 0021B which is 11 days.
- ▶ Delivery time is in working days from receipt of orders placed before 4pm (UK) and 3pm (NI).
- ▶ Flashing colour NCS: S 7500-N. (Nearest RAL colour: 7043). Twin and combination flashings are also available in titanium zinc, copper and a wide range of colours to match the roof window finish.
- ▶ Other recessed combination flashing options are available subject to lead times. Contact our customer support team for details on recessed triple and quatro options.

### SUPPORT TRIMMERS

- VELUX support trimmers provide structural support and also a harmonious finish.
- Available in white or pine to match the roof windows.
- Available in three different lengths.
- The EBY is used for frame gaps of 18mm between the roof windows and the EKY for 100mm gaps.

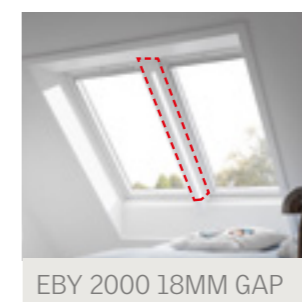

EBY 2000 18MM GAP

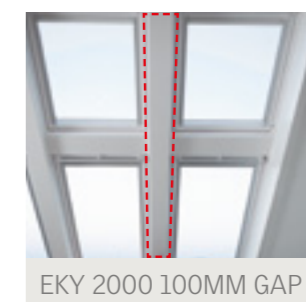

EKY 2000 100MM GAP



More flashings options can be found in our extended online brochure

#### Support trimmer for 18mm frame gap – white roof windows

<b>EBY W20 2000</b>	2,000mm long.	£140
<b>EBY W27 2000</b>	2,700mm long.	£176
<b>EBY W35 2000</b>	3,500mm long.	£232

#### Support trimmer for 100mm frame gap – white roof windows

<b>EKY W20 2000</b>	2,000mm long.	£232
<b>EKY W27 2000</b>	2,700mm long.	£258
<b>EKY W35 2000</b>	3,500mm long.	£294

#### Support trimmer for 18mm frame gap – pine roof windows

<b>EBY W20 3000</b>	2,000mm long.	£140
<b>EBY W27 3000</b>	2,700mm long.	£176
<b>EBY W35 3000</b>	3,500mm long.	£232

#### Support trimmer for 100mm frame gap – pine roof windows

<b>EKY W20 3000</b>	2,000mm long.	£232
<b>EKY W27 3000</b>	2,700mm long.	£258
<b>EKY W35 3000</b>	3,500mm long.	£294

### Roof window profile set (For use with on site flashing)

External frame size (nominal w x h) cm

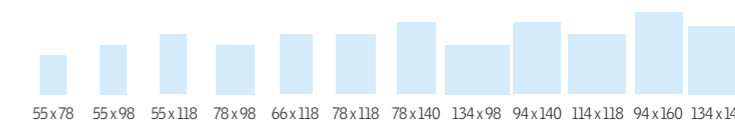

Code		CK02	CK04	CK06	MK04	FK06	MK06	MK08	UK04	PK08	SK06	PK10	UK08
<b>ZWC S0001</b>	Click-on external window profiles.	£31	£32	£33	£33	£34	£35	£36	£39	£39	£40	£40	£43

- ▶ Support trimmers have a delivery time of 7 days.
- ▶ Roof window profile sets have a delivery time of 2 days.
- ▶ Delivery time is in working days from receipt of orders placed before 4pm (UK) and 3pm (NI).





## Blinds and shutters for any room

Control the amount of daylight and temperature within the room

Featured: VELUX duo blackout blind (DFD SK10 4561 and DFD S04 4561)

### How to select your blinds

- 1 Select type**  
Choose an interior and/or exterior VELUX blind or shutter that meets your requirements in terms of heat protection, blackout, light adjustment or insect protection.
- 2 Select colour and design**  
Our blinds are available in an array of exciting colours and designs.
- 3 Select operation method**  
Choose between manual or automatic operation. Always consider electrically-operated products for out-of-reach situations.
- 4 Select the right size**  
Check the data plate which details the type and size of your roof window.

VELUX roof window data plates



- 5 Installed in minutes**  
VELUX interior blinds are easily installed with our unique Pick&Click!™ system. Follow the instructions, and your blinds will be fitted in minutes.

Pick&Click!™

VELUX roof windows are fitted with pre-installed brackets to ease installation and to ensure a perfect fit every time.



### Sizing chart

All sizes must be ordered using the same code shown on the roof window data plate.

		55x70	55x78	55x98	55x118	78x98	66x118	70x118	78x118	78x140	134x98	94x140	114x118	94x98	94x160	134x140
Current Size		CK01	CK02	CK04	CK06	MK04	FK06		MK06	MK08	UK04	PK08	SK06	PK04	PK10	UK08
2002-2013		C01	C02	C04	C06	M04	F06		M06	M08	U04	P08	S06	P04	P10	U08
1992-2001			102	104		304	206		306	308	804		606		410	808
Before 1992		9		6		1		5		2	7		4		3	8

## Duo and blackout blinds

### Blackout blinds



The VELUX blackout blind offers almost complete blackout for darkness anytime. Ideal for installing in bedrooms to ensure a good night's sleep.

- Fabric offers complete blackout
- Stepless positioning
- Available in 24 colours
- Oeko-Tex® certified

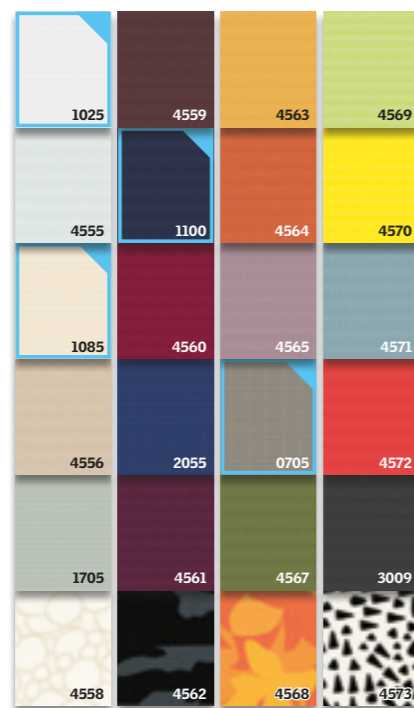

Standard colours Price Group 1

### Duo blackout blinds

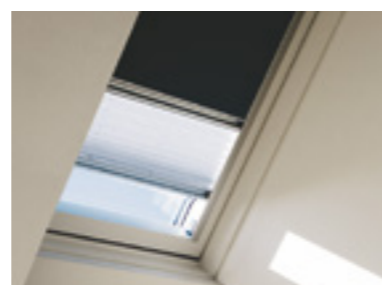

The VELUX duo blind is a blackout blind and a pleated blind in one. It offers the best of both worlds: blackout at any time and softly diffused natural light all day.

- Fabric offers complete blackout
- Stepless positioning
- Flat and pleated cloth
- Available in 24 colours
- Softly diffuses incoming daylight
- Oeko-Tex® certified



1016

Upgrade from blackout to duo blackout for  
**£22**  
ex VAT only

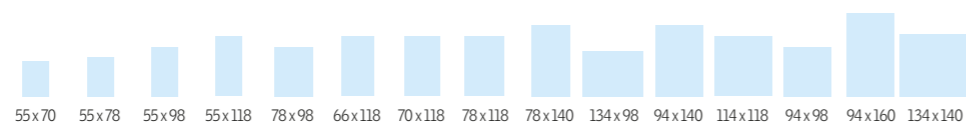

Blackout blinds. Please refer to page 55 for your product code.

Manual	DKL	Price Group 1	£60	£62	£66	£70	£72	£74	£74	£76	£82	£100	£90	£96	£78	£96	£110
		Price Group 2	£70	£72	£76	£80	£82	£84	£84	£86	£92	£110	£100	£106	£88	£106	£120
Electric	DML	Price Group 1	£184	£186	£190	£194	£196	£198	£198	£200	£206	£224	£214	£220	£202	£220	£234
		Price Group 2	£194	£196	£200	£204	£206	£208	£208	£210	£216	£234	£224	£230	£212	£230	£244
Solar	DSL	Price Group 1	£208	£210	£214	£218	£220	£222	£222	£224	£230	£248	£238	£244	£226	£244	£258
		Price Group 2	£218	£220	£224	£228	£230	£232	£232	£234	£240	£258	£248	£254	£236	£254	£268
Duo blackout	DFD	Price Group 1	£82	£84	£88	£92	£94	£96	£96	£98	£104	£122	£112	£118	£100	£118	£132
		Price Group 2	£92	£94	£98	£102	£104	£106	£106	£108	£114	£132	£122	£128	£110	£128	£142

Electrically powered products combined with a manual VELUX roof window require a control unit KUX 110. Refer to page 62 for details.

- ▶ All blinds and shutters have a delivery time of up to 7 days.
- ▶ Delivery time is in working days from receipt of orders placed before 4pm (UK) and 3pm (NI).

## Children's collection

### Star Wars & VELUX Galactic Night Collection



Our Star Wars & VELUX Galactic Night Collection is a range of blackout blinds designed for tough Jedi knights and other adventurers. Choose from 4 exciting designs.



4710 4711 4712 4713

© & ™ Lucasfilm Ltd.

### Disney & VELUX Dream Collection



Our Disney & VELUX Dream Collection is a range of blackout blinds designed for the young – and the young at heart. From Mickey, Bambi and Planes to Minnie, Winnie the Pooh and Princesses – there's something for everyone.

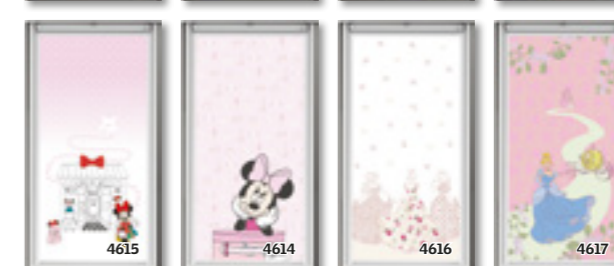

© Disney. © Disney. Based on the *Winnie the Pooh* works by A. A. Milne and E. H. Shepard.

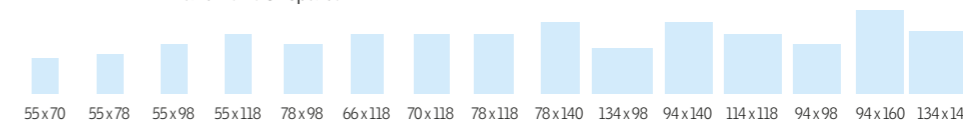

Blackout blinds. Please refer to page 55 for your product code.

Manual	DKL	Star Wars	£82	£84	£88	£92	£94	£96	-	£98	£104	£122	£112	£118	£100	£118	£132
		Disney Collection	£82	£84	£88	£92	£94	£96	-	£98	£104	£122	£112	£118	£100	£118	£132

- ▶ All blinds and shutters have a delivery time of up to 7 days.
- ▶ Delivery time is in working days from receipt of orders placed before 4pm (UK) and 3pm (NI).



Improves insulation by up to **26%**

## Blackout energy and Venetian

### Blackout energy blind



- Fabric offers complete blackout.
- Stepless positioning.
- Double pleated cloth.
- Available in 12 colours.
- Installs in minutes with our unique Pick&Click!™ system.
- Free positioning in the window frame.
- Protects against cold from the outside.
- No visible cords.

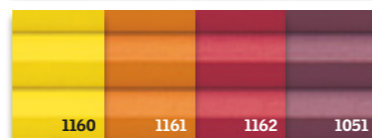
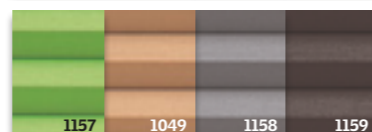
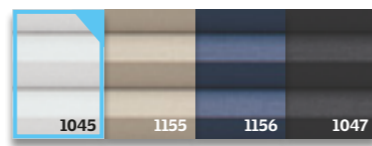

Standard colours Price Group 1

### Light dimming energy blind

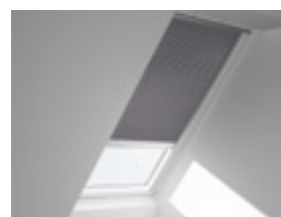

- Light dimming.
- Protects against cold from the outside.
- Privacy and diffusion of incoming daylight.
- Available in both solar and electrical powered versions.
- Operated by remote control for easy operation with possibility for programming.
- Installs in minutes with our unique Pick&Click!™ system.
- Double pleated cloth.
- Available in 12 colours.

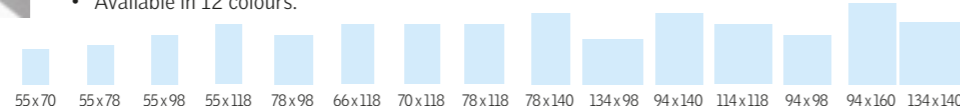

**Blackout energy blinds.** Please refer to page 55 for your product code.

Manual	FHC	Price Group 1														
		£76	£80	£86	£90	£94	£96	£96	£100	£108	£130	£118	£126	£102	£124	£144
		Price Group 2														
		£86	£90	£96	£100	£104	£106	£106	£110	£118	£140	£128	£136	£112	£134	£154

**Light dimming energy blinds.** Please refer to page 55 for your product code.

Electric	FMC	Price Group 1														
		£200	£204	£210	£214	£218	£220	£220	£224	£232	£254	£242	£250	£226	£248	£268
		Price Group 2														
		£210	£214	£220	£224	£228	£230	£230	£234	£242	£264	£252	£260	£236	£258	£278
Solar	FSC	Price Group 1														
		£224	£228	£234	£238	£242	£244	£244	£248	£256	£278	£266	£274	£250	£272	£292
		Price Group 2														
		£234	£238	£244	£248	£252	£254	£254	£258	£266	£288	£276	£284	£260	£282	£302

### Venetian blinds



The VELUX Venetian blind gives you complete control of the light and is the ideal solution for rooms where you want to adjust the amount and direction of incoming light. As the blinds are made of aluminium they are also very easy to wipe clean and an ideal solution for rooms with high levels of humidity, such as kitchens and bathrooms.

- **Complete light control**  
Control the amount and direction of incoming light and shadows.
- **Award-winning design**  
Praised for the unique tilt mechanism and cordless operation.
- **Colours**  
Choose from nine colour choices.

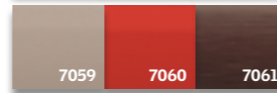
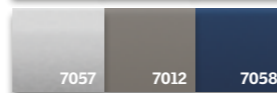
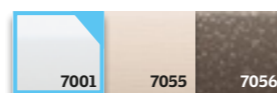

Standard colours Price Group 1

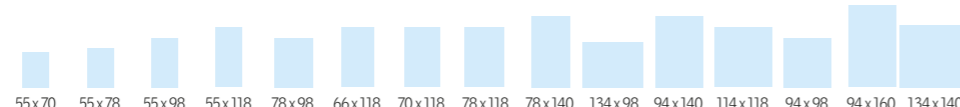

**Venetian blinds.** Please refer to page 55 for your product code.

Manual	PAL	Price Group 1														
		£76	£80	£86	£90	£94	£96	£96	£100	£108	£130	£118	£126	£102	£124	£144
		Price Group 2														
		£86	£90	£96	£100	£104	£106	£106	£110	£118	£140	£128	£136	£112	£134	£154

Electrically powered products combined with a manual VELUX roof window require a control unit KUX 110. Refer to page 62 for details.

- ▶ All blinds and shutters have a delivery time of up to 7 days.
- ▶ Delivery time is in working days from receipt of orders placed before 4pm (UK) and 3pm (NI).

## Pleated

### Flying pleated blinds



The VELUX pleated blind provides an excellent way to control the daylight in your room and allows you to create colourful and original light effects that can complement your personal choice of furniture and decor. It can be positioned anywhere on the window.

This makes the blind ideal for installing in living rooms or dining areas.

- **Colourful light effects**  
Softens incoming light.
- **Decoration**  
Beautiful decoration for living rooms.
- **Flexible positioning**  
Dual control bars allow you to adjust the blind from both the top and the bottom of the window, letting in exactly the right light.
- **Upgrade**  
Available in electric operation.

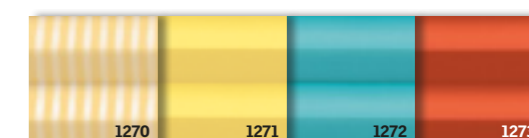
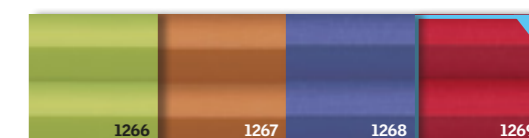
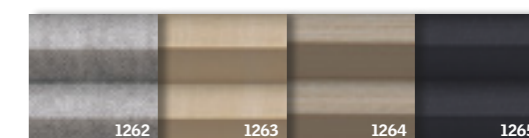
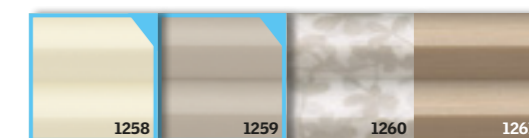

Standard colours Price Group 1

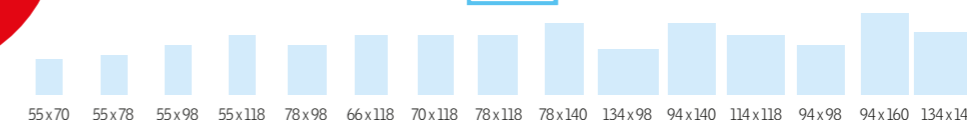

View 100s of options at [veluxblindsdirect.co.uk](http://veluxblindsdirect.co.uk)

**Pleated blinds.** Please refer to page 55 for your product code.

Manual	FHL	Price Group 1																
		£60	£62	£66	£70	£72	£74	£74	£76	£82	£100	£90	£96	£78	£96	£110		
		Price Group 2																
		£70	£72	£76	£80	£82	£84	£84	£86	£92	£110	£100	£106	£88	£106	£120		
Electric	FML	Price Group 1																
		£184	£186	£190	£194	£196	£198	£198	£200	£206	£224	£214	£220	£202	£220	£234		
		Price Group 2																
		£194	£196	£200	£204	£206	£208	£208	£210	£216	£234	£224	£230	£212	£230	£244		
Solar	FSL	Price Group 1																
		£208	£210	£214	£218	£220	£222	£222	£224	£230	£248	£238	£244	£226	£244	£258		
		Price Group 2																
		£218	£220	£224	£228	£230	£232	£232	£234	£240	£258	£248	£254	£236	£254	£268		

**Blinds for flat roof windows.** Please refer to page 55 for your product code.

Window size	060060	060090	080080	090090	100100	090120	120120	100150	150150
<b>FMG Electric Pleated Blinds</b>	£261	£264	£270	£275	£281	£287	£292	£289	-
<b>FMK Electric Light Dimming Energy Blinds</b>	£281	£284	£290	£295	£301	£307	£312	£318	£371
<b>FSK Solar Light Dimming Energy Blind</b>	£286	£289	£295	£300	£306	£312	£317	£323	£376
<b>KUX 110 – Additional control system to allow FMG blind to be fitted to CFP fixed version.</b>									£94

### FMG – Electric Pleated

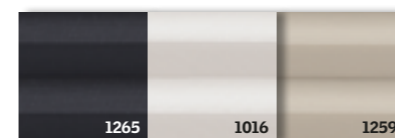

### FMK and FSK – Light Dimming Energy

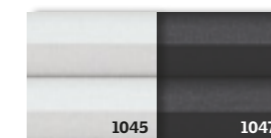

- ▶ All blinds and shutters have a delivery time of up to 7 days.
- ▶ Delivery time is in working days from receipt of orders placed before 4pm (UK) and 3pm (NI).

## Roman blinds and roller

### Roman blinds



Create a soft and warm atmosphere with the new decorative VELUX Roman blinds. Explore the potential of beautiful fabrics and be inspired by the soft styling effects that make this collection refined and original.

- **Colours** – Choose from twenty elegant and decorative colours.
- **Upgrade** – Interchangeable fabrics.
- **Maintenance** – Fabric can be removed for easy cleaning.

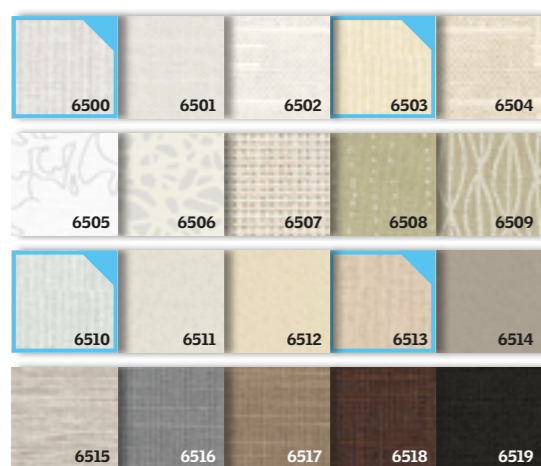

Standard colours Price Group 1

New styling in no time, the Roman blind fabrics can be removed for easy cleaning. All Roman blind fabrics can be bought separately for flexibility in style. Just choose the right one for you.

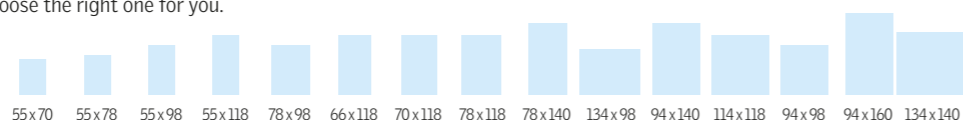

Roman blinds. Please refer to page 55 for your product code.

Manual	FHB	Price Group 1	£76	£80	£86	£90	£94	£96	£96	£100	£108	£130	£118	£126	£102	£124	£144
		Price Group 2	£86	£90	£96	£100	£104	£106	£106	£110	£118	£140	£128	£136	£112	£134	£154
Repl. cloth for Roman blind	ZHB	Price Group 1	£38	£40	£42	£44	£46	£48	£48	£50	£54	£64	£58	£62	£52	£62	£72
		Price Group 2	£48	£50	£52	£54	£56	£58	£58	£60	£64	£74	£68	£72	£62	£72	£82

Roller blinds. Please refer to page 55 for your product code.

Manual	RFL	Price Group 1	£60	£62	£66	£70	£72	£74	£74	£76	£82	£100	£90	£96	£78	£96	£110
		Price Group 2	£70	£72	£76	£80	£82	£84	£84	£86	£92	£110	£100	£106	£88	£106	£120
Electric	RML	Price Group 1	£184	£186	£190	£194	£196	£198	£198	£200	£206	£224	£214	£220	£202	£220	£234
		Price Group 2	£194	£196	£200	£204	£206	£208	£208	£210	£216	£234	£224	£230	£212	£230	£244
Solar	RSL	Price Group 1	£208	£210	£214	£218	£220	£222	£222	£224	£230	£248	£238	£244	£226	£244	£258
		Price Group 2	£218	£220	£224	£228	£230	£232	£232	£234	£240	£258	£248	£254	£236	£254	£268

Electrically powered products combined with a manual VELUX roof window require a control unit KUX 110. Refer to page 62 for details.

- ▶ All blinds and shutters have a delivery time of up to 7 days except the Roman blind (FHB) which is 13 days.
- ▶ Delivery time is in working days from receipt of orders placed before 4pm (UK) and 3pm (NI).

### Roller blinds



The VELUX roller blind provides basic privacy whilst still allowing natural light in. A VELUX roller blind is an effective and practical solution that offers protection and looks good. Roller blinds are therefore well suited for living rooms, home offices, playrooms, and rooms where you want basic privacy and the ability to diffuse the light.

- **Privacy**  
Provides basic privacy.
- **Harmonious light**  
Softens the incoming light.
- **Upgrade**  
Available in solar powered and electric operation.



## External awning blinds and shutters

### External awning blinds

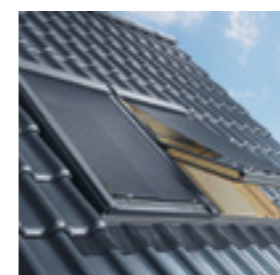

The VELUX awning blind is an external blind perfectly suited to stop strong sunlight and heat before it reaches the pane on your roof window. These unique blinds are ideal for keeping rooms cool and reducing the heat of the sun on hot summer days.

- **Sun yes, heat no**  
Reduce heat by up to 73%.
- **Quality**  
Weather resistant fabric for longer lasting performance.
- **Easy installation**  
Install from the inside in minutes.
- **Upgrade**  
Available in solar powered and electric operation.

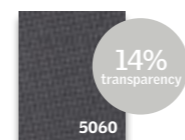
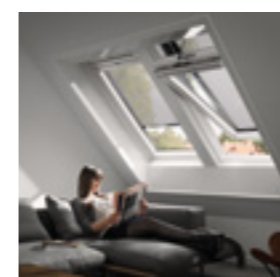

### Roller shutters

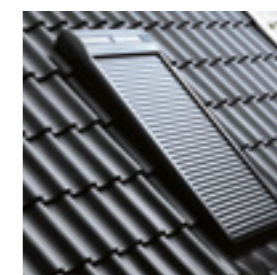

- **Complete light control**  
Keeps out the light and prevents overheating.
- **Energy saving**  
Provides insulation in cold weather.
- **Security**  
Provides additional security and protection from the elements.
- **Upgrade**  
Available in electric (for use with VELUX INTEGRA® electric roof windows) and solar (for use with solar or manual roof windows).
- **Sound reduction**  
Provides additional sound insulation against rainfall and hail.

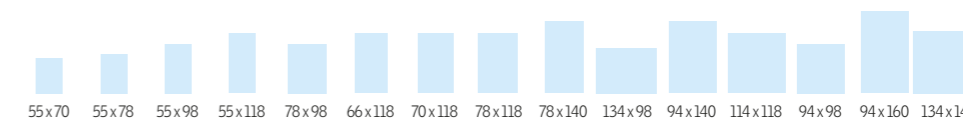
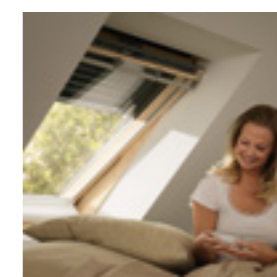

Awning blinds. Please refer to page 55 for your product code.

Manual	MHL	£44	£44	£44	£44	£54	£52	£56	£54	£54	£72	£60	£70	£60	£60	£72
Electric	MML	£264	£268	£274	£278	£280	£282	£282	£286	£292	£308	£306	£314	£288	£324	£330
Solar	MSL	£354	£358	£364	£368	£370	£372	£372	£376	£382	£398	£396	£404	£378	£414	£420

For roof windows manufactured before April 2001 you must also order ZOZ 228 to fit awning blinds MML and MSL £32

Roller shutters

Manual	SHL	£216	£216	£230	£238	£246	£248	-	£258	£272	£296	£294	£300	£264	£308	£346
Electric	SML	£322	£322	£344	£356	£366	£370	£370	£384	£406	£442	£440	£446	£396	£462	£516
Solar	SSL	£364	£364	£388	£402	£414	£418	£418	£434	£460	£500	£496	£504	£446	£522	£584

ZOZ 213K adaptor plate allows operation of solar powered roof windows with MSL or SSL. £52

Awning blinds for flat roof windows. Please refer to page 55 for your product code.

MSG heat-reduction awning blind. Fitted between glazing and polycarbonate dome. Solar powered. Available in white (6090).

Window size	060060	060090	080080	090090	100100	090120	120120	100150	150150
MSG solar heat reduction awning blinds	£286	£289	£295	£300	£306	£312	£317	£323	-

- ▶ All blinds and shutters have a delivery time of up to 7 days.
- ▶ Delivery time is in working days from receipt of orders placed before 4pm (UK) and 3pm (NI).



## Accessories

### Rod controls

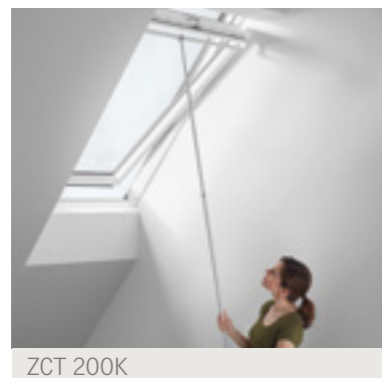

ZCT 200K



ZCT 100

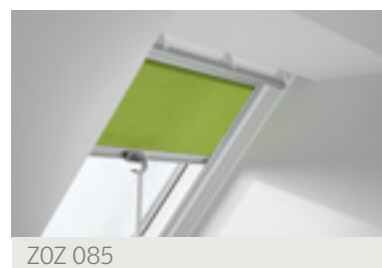

ZOZ 085

### Locks and restrictors



ZOZ 012K



ZOZ 010K S011

### Electric accessories



KUX 110

### Roof window kits



ZZZ 129 – White polyurethane repair kit

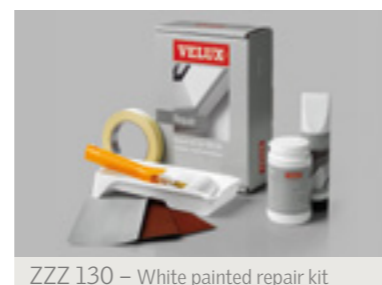

ZZZ 130 – White painted repair kit



ZZZ 131 – Care kit for white roof windows

### Accessories

Code	Description	Price
<b>Rod controls</b>		
ZCT 200K	Telescopic pole 100-180cm for operation of centre-pivot roof windows.	£25
ZCT 100	100cm extension for ZCT 200K.	£15
ZOZ 085	Pole adaptor for VELUX manual blinds that are out of reach to allow operation with rod control (ZCT 200K). One per blind.	£6
<b>Locks and restrictors</b>		
ZOZ 012K	Security lock for centre-pivot roof windows.	£42
ZOZ 010K S011	Opening restrictor with key for centre-pivot roof windows. Suitable for roof windows of frame height 98cm and above.	£42
<b>Roof window kits</b>		
ZZZ 129	Repair kit for white polyurethane roof windows. Includes filler, sandpaper and polyurethane paint.	£42
ZZZ 130	Repair kit for white painted roof windows. Includes filler, white paint, sandpaper, roller and paintbrush.	£33
ZZZ 131	Care kit for white painted roof windows. Includes cleaning solution, maintenance protector and cloth.	£26
<b>Electric accessories</b>		
KUX 110	Control system for operation of single electrical accessory on a manual roof window or fixed flat roof window.	£94

- ▶ All rod controls have a delivery time of 2 days except ZOZ 085 which are 7 days.
- ▶ All locks and restrictors have a delivery time of 7 days.
- ▶ All maintenance kits have a delivery time of 2 days.
- ▶ All electric accessories have a delivery time of 7 days.
- ▶ Delivery time is in working days from receipt of orders placed before 4pm (UK) and 3pm (NI).

VELUX accessories



Using our size guide

Note all sizes refer to the external frame size of the roof window and not the glazed area. Please refer to installation instructions for trimmed opening sizes.

For product sizes and specifications not listed in this brochure, please visit [velux.co.uk](http://velux.co.uk) or contact us on **01592 778 225**.

Looking to replace your existing VELUX roof window? Use these handy size charts to locate your current window code and the replacement code.

For example, if your current window code is GGL4, the replacement size code for this is SK06.

All measurements are in mm and cm as indicated.

### Roof Windows

				GGL 425 P25 PK25			
	GGL 9 101 CO1 CK01					GGL 601 S01 SK01	
	GGL GGU 102 CO2 CK02						
	GGL GGU 6 104 CO4 CK04	GGL GGU 204 FO4 FK04	GGL GGU 1 304 MO4 MK04	GGL GGU 31 404 PO4 PK04		GGL GGU 7 804 U04 UK04	
	GGL GGU 5 206 FO6 FK06	GGL GGU 14 306 MO6 MK06	GGL GGU 406 PO6 PK06	GGL GGU 4 606 S06 SK06			
	GGL GGU 2 308 MO8 MK08	GGL GGU 408 PO8 PK08	GGL GGU 10 608 S08 SK08	GGL GGU 8 808 U08 UK08			
		GGL GGU 13 310 M10 MK10	GGL GGU 3 410 P10 PK10	GGL GGU 610 S10 SK10	GGL GGU 810 U10 UK10		
		GGL 11 312 M12 MK12					

### VELUX CABRIO® Balcony

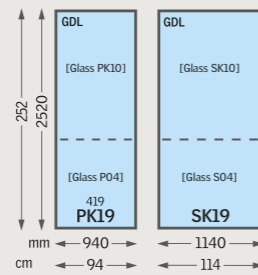

### Roof Terrace

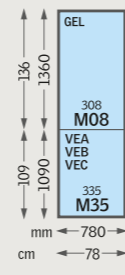

### Sun Tunnels

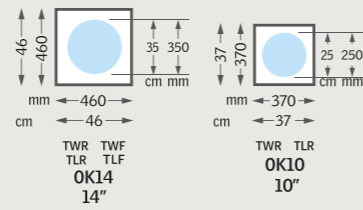

### Flat Roof Sun Tunnel

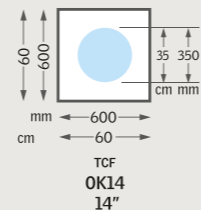

### Rooflights for Uninhabited Spaces

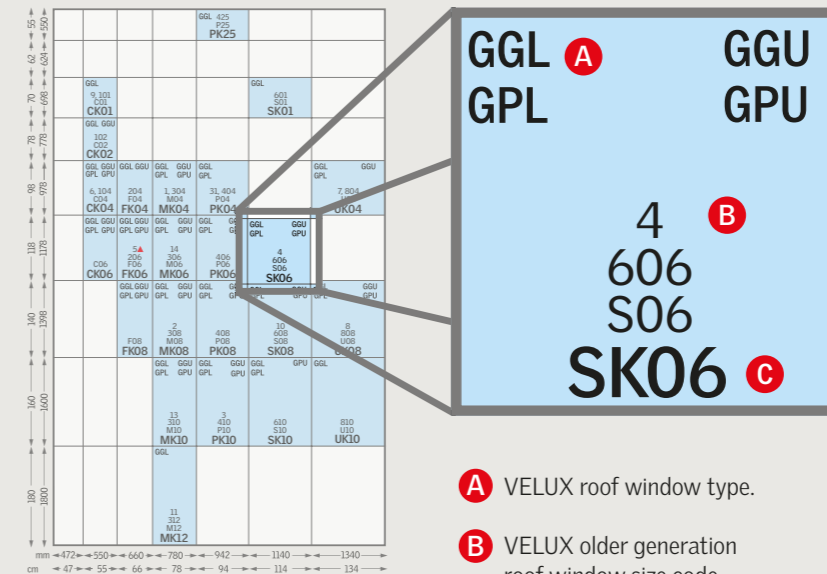
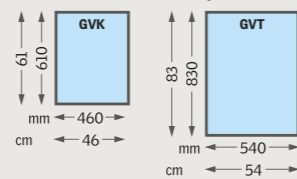

- A** VELUX roof window type.
- B** VELUX older generation roof window size code.
- C** VELUX current size code.

### Sloped Fixed Additional Elements

	GIL GIU 334 M34 MK34	GIL GIU 434 P34 PK34	GIL GIU 634 S34 SK34	GIL GIU 834 U34 UK34
--	-------------------------------	-------------------------------	-------------------------------	-------------------------------

### Flat Roof Windows

CFP CVP 060060					
	CFP CVP 080080				
CFP CVP 060090		CFP CVP 090090			
		GFP CVP CSP CXP 100100			
	CFP CVP CXP 090120		CFP CVP CSP CXP 120120		
		GFP CVP 100150		GFP CVP 150150	

Note: All sizes for flat roof windows refer to structural opening sizes.

### Vertical Elements

	VFE VIU 1/2-60 331 M31 MK31	VFE VIU 3-60 431 P31 PK31	VFE VIU 4/10-60 631 S31 SK31	VFE VIU 7/8-60 831 U31 UK31
	VFE VIU 1/2-95 334 M34 MK35	VFE VIU 3-95 434 P34 PK35	VFE VIU 4/10-95 634 S34 SK35	VFE VIU 7/8-95 834 U34 UK35
	VFE 1/2-115 336 M36 MK36	VFE 436 P36 PK36	VFE 636 S36 SK36	VFE UK36
	VFE 338 M38 MK38	VFE 438 P38 PK38	VFE 638 S38 SK38	VFE UK38

For more details visit [velux.co.uk](http://velux.co.uk)



VELUX Company Ltd  
Woodside Way  
Glenrothes  
Fife  
Scotland  
KY7 4ND  
Tel: 01592 778 225  
Fax: 01592 776 980  
sales@velux.co.uk  
velux.co.uk

*Bringing light to life*™

**VELUX®**

VELUX  
product range

©2017 VELUX GROUP, VELUX®, VELUX logo, VELUX INTEGRA®, VELUX CABRIO®, VELUX CABRIO® and Pick&Click™ are registered trademarks. ThermoTechnology™ is a trademark. The io-homecontrol® registered trademark and logo are owned by the io-homecontrol association.

XGB 12003